



BERGERLN

PU Decorative Materials

 **BERGERLN**

PU DECORATIVE MATERIALS



BERGERLN

PU DECORATION PRODUCTS
MANUFACTURING EXPERTS



The Natural Habitat Of Product



Green Health Products



International Standard Quality

B E R G E R L N P U D E C O R A T I O N G

**HEART LIVE PLACE
IS BERGERLN**

Bergerln Give You The Classical Beauty Which You Want

Be professional in PULive in the PU industry





BERGERLN
HIGH-END BRAND
PU DECORATIONG



Natural Habitat Of Product



Green Health Products



International Standards Quality

CONTENTS



BERGERLN
HIGH-END BRAND
PU DECORATIONG

P007—010
MODERN STYLE
CONNECTED LAMP
SLOT SERIES

P011—022
ORIGINAL CEILING
SERIES

P023—036
CARVED CORNICE
SERIES

P037—044
CARVED CORNICE
SERIES

P045—060
PURE CORNICE
SERIES

P061—072
PURE CORNICE
SERIES

P073—086
ORIGINAL CEILING
SERIES

P087—096
CARVED DECORATION
SERIES

P097—104
LAMP HOLDER
SERIES

P105—106
CHINESE STYLE
SMALLPOX SERIES

P107—110
CEILING MOLDING
SERIES

P111—112
EXQUISITE TRUNK
SERIES

P113—118
SETTING WALL
SERIES

P119—120
OUTSIDE THE WINDOW
SERIES

P117—122
DOOR /WINDOW COVER
SERIES

P123—123
ROMAN COLUMN
SERIES

P124—126
CULTURE STONE
SERIES

Classic heritage grade supreme

INTRODUCE



PRODUCT INTRODUCTION

BERGERLN special glue for PU product is made of nano-polymer materials. The glue is dedicated to contact and repair PU products and solve the cracking problem of PU product.

PRODUCT FEATURES

1. Environmental protection, Health and Safety, No heavy metals and other harmful substances.
2. A smooth surface will appear after solidify, anti-mildew and anti-bacterial.
3. Waterproof, anti-acid and alkali.
4. Anti-oxidation, no color fading.
5. No shrink, no crack and long life span.
6. Clean easy simple operation.
7. Long storage time.
8. Good viscosity, widely application.

Since its inception, the company has experienced many years of development, has become the industry research and development, production, sales and other aspects of the forefront of the enterprise. The factory has a certain scale of production workshop, the number of employees up to hundreds of people, with independent design and research department, can meet the different needs of customers multiple production lines can also ensure adequate supply. Our products are sold at home and abroad, sales network throughout the United States, Canada, Japan, South Africa, and other places. Project products from R & D team establishment, design, drawing, proofing, sculpture, renovation, mold making... To meet the requirements of business partners in a more efficient, professional and comprehensive manner.

Looking to the future, the company will continue to strengthen team spirit and good communication with customers, machinery and equipment modernization, promote building materials decoration business optimization, strengthen marketing, to achieve better performance targets. Our factory always adheres to the "design tomorrow, play today" business philosophy and "customer-oriented" service attitude, is willing to make progress with all customers! of the line board after construction.

BERGERLN CONSTRUCTION PROCESS



1. Establish a horizontal reference line on wall for the cornice.



2. Marked on the wall and ceiling using the cornice to prepare for corner joints.



3. Saw at the marked point of the cornice, and better to cut more than 5mm.



4. Apply construction glue to contact points of cornice to wall and ceiling.



5. Using Pressure gun for snailing, if the wall is too strong use the steel snail.



6. The joints between the cornice can be amended with the sanding paper.



7. Fasten the cornice with the snail gun or steel snail, and fill the snail holes with plaster.



8. Apply filler (silicone & plaster) to fill up gaps.



9. Cleaning overflowed glue with the waterish cloth.



10. Allow to dry, sand smooth with sanding paper and finished with paint.



BERGERLN
Condole Top 1

Class B1 fireproof, sound-absorbing, moisture-proof, heat insulation
 No cracking, no twisting, no deformation, no warping head, no putty
 Less waste, high strength, high hardness, high whiteness
 It can be nailed, saw, repaired, sculpted and customized

Specifications
Dimensions
BG-3001
 2400 × 415 × 145
BG-3001A
 600 × 600

BG3001 Section drawing and detailed dimensions

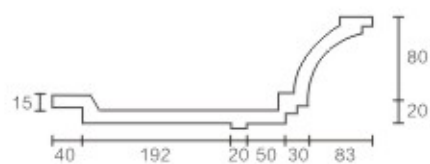

BG3001-415

The upper white acts as an under coat for any decorative paint.



BERGERLN
Condole Top 2

The surface is bright and clean
 Water chestnut standard
 Straightness is good
 Good stereo effect
 Corner finished product process
 Assembly type installation process

BERGERLN pu after several years of unremitting efforts, has been highly recognized by the market, favored by consumers. Adhering to the "focus, focus, professional" the spirit of craftsman in the development of prefabricated condole top modelling contracted fashion, with sound-absorbing physical properties, heat insulation, moistureproof, no cracking, no distortion, no deformation, not become warped head, high strength, high hardness, high whiteness, nails, sawing, can be repaired, sculpture, can be customized special advantages, such as, at the same time also have not go be bored with child, prefabricated installation, less waste, good three-dimensional effect, smooth surface, water chestnut standard, good straightness and other effects, the implementation of standardization, modular, fine differentiation of assembly process installation.



BG-7090
2400×220

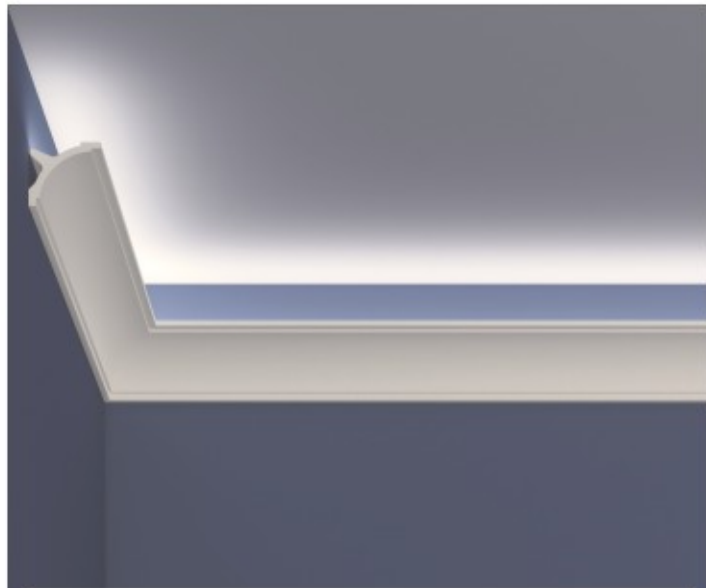
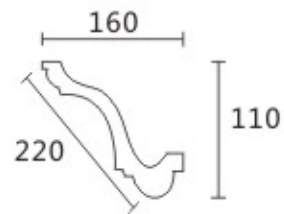

BG-7074
2400×113

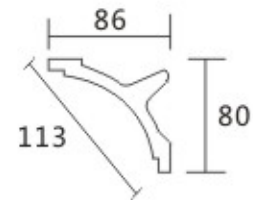

BG-7075
2400×140×73

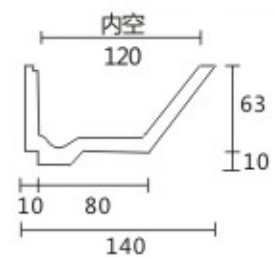

BG-7076
2400×94

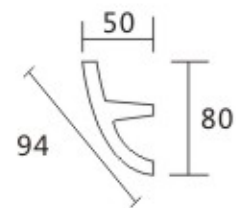

The upper white acts as an under coat for any decorative paint.



BG-6075
2400×155×50

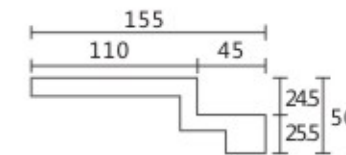

BG-6068
2400×168×30

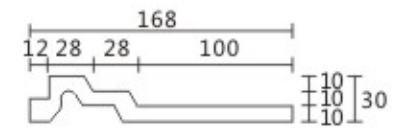

BG-8066
2400×222×55

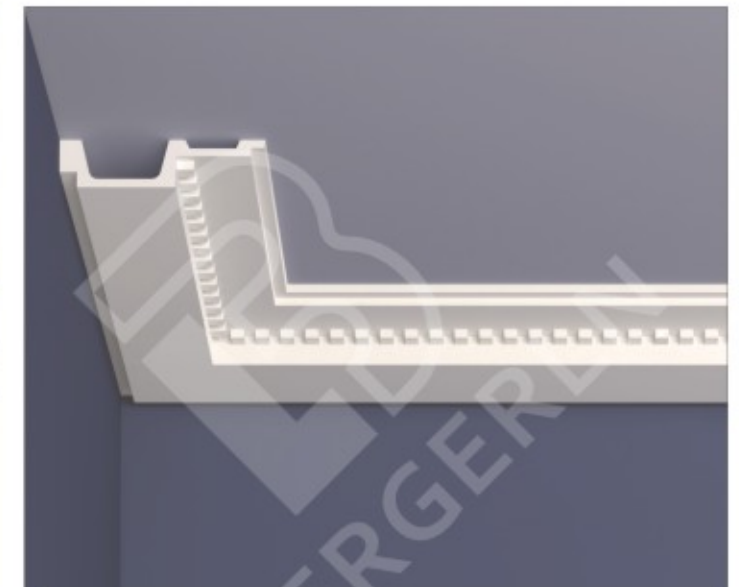
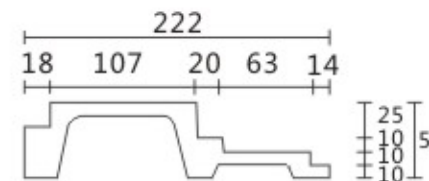

BG-8066
2400×222×55

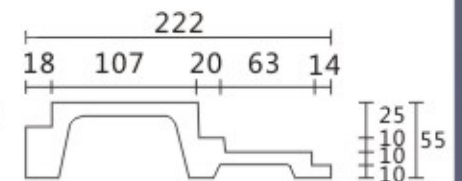

Welcome to choose **bergerln pu**



Size:mm





Size:mm

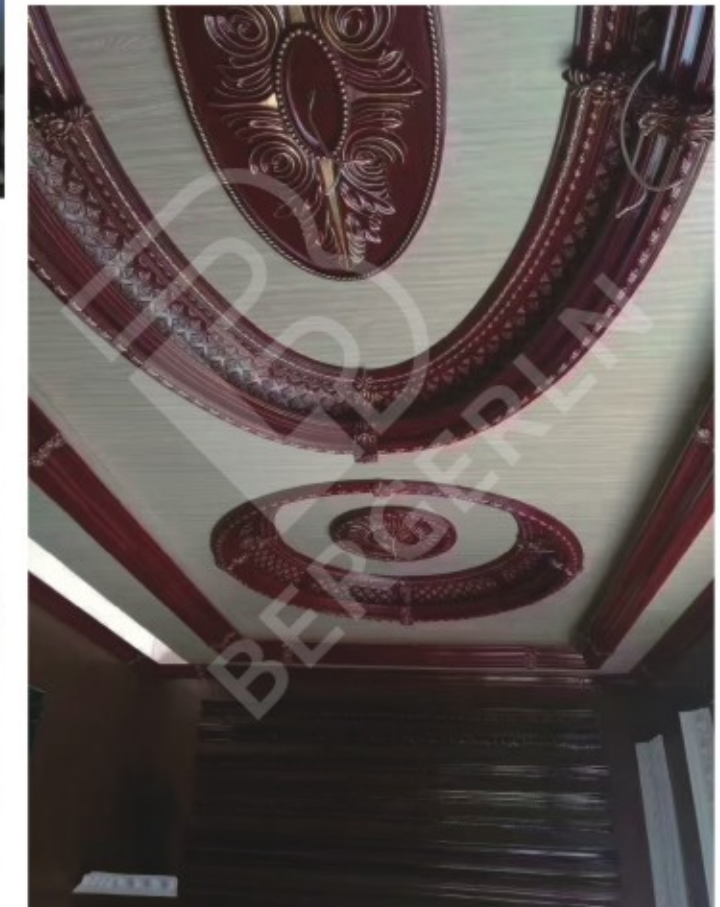
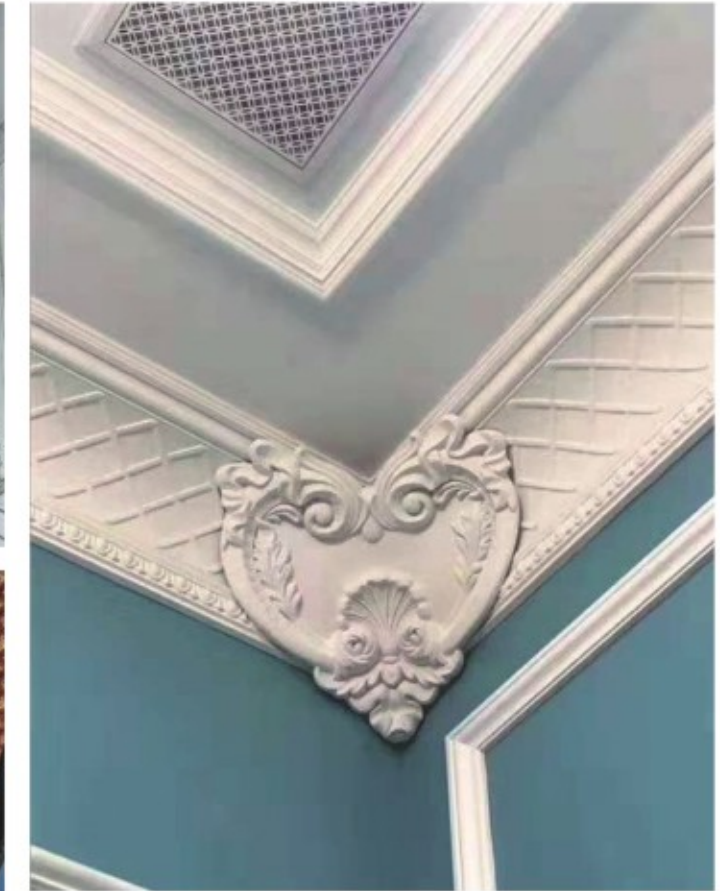

Construction height
安装高度:180

①
IN CIRCULAR
(内圆)

BG-Y101

BG-Y102

BG-Y103

BG-Y104

Construction height
安装高度:300

②
IN CIRCULAR
(内圆)

BG-Y105

BG-Y106

BG-Y107

BG-Y108

Construction height
安装高度:160

③
IN CIRCULAR
(内圆)

BG-Y115

BG-Y116

BG-Y117

BG-Y118

Construction height
安装高度:180

④
IN CIRCULAR
(内圆)

BG-Y101-1B

BG-Y101-2B

BG-Y101-3B

BG-Y101-4B

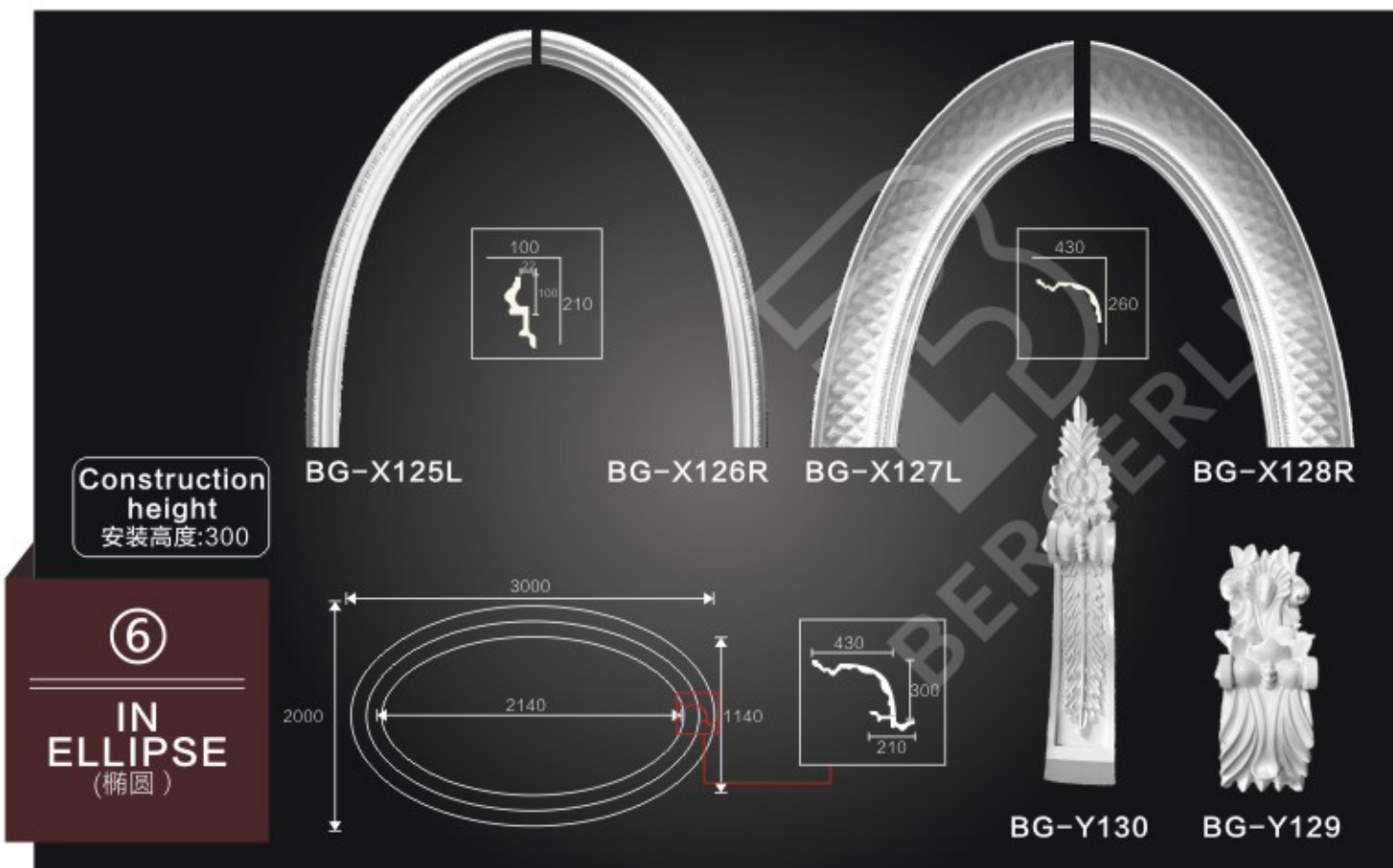
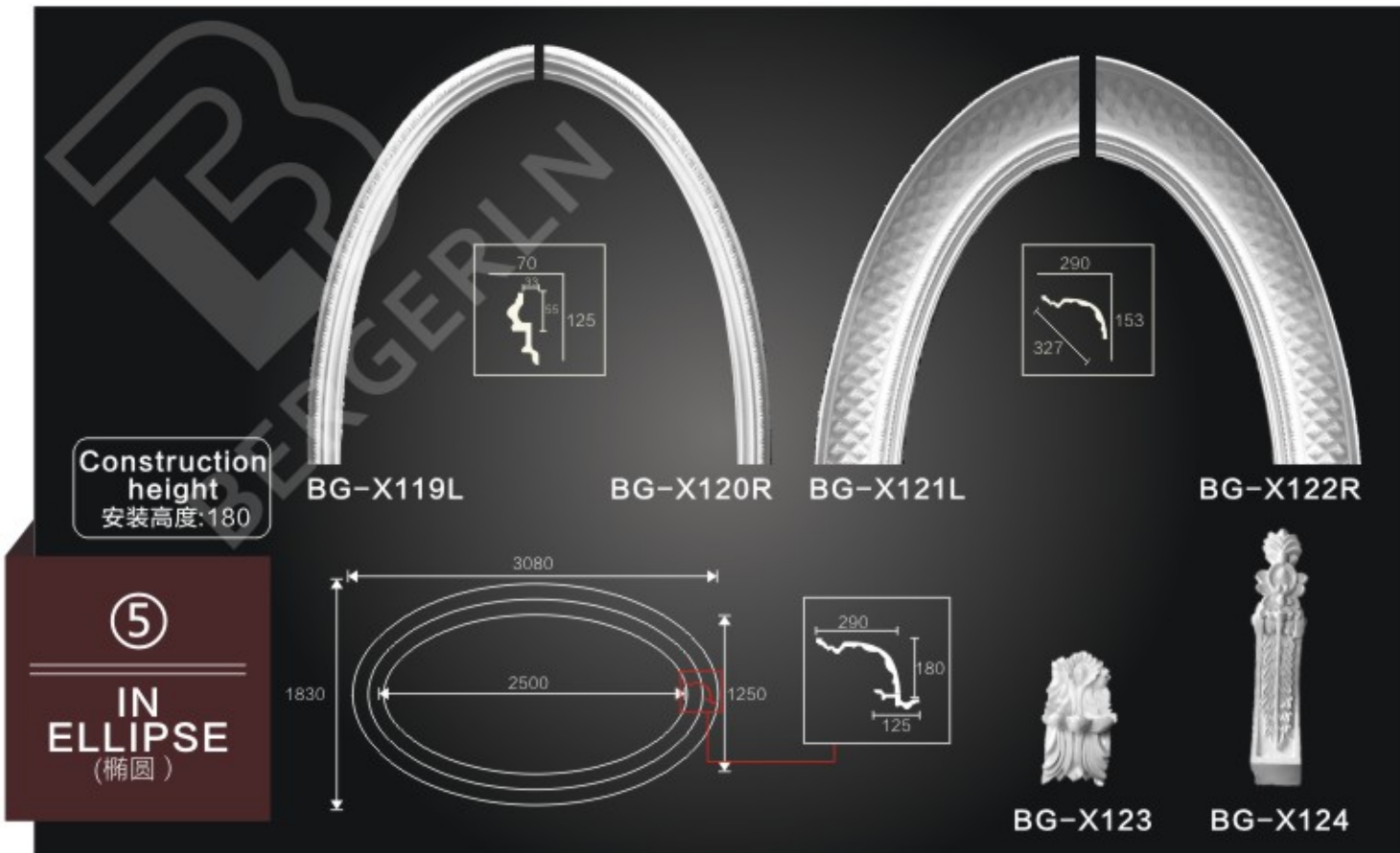

Size:mm





Size:mm





Size:mm





Size:mm

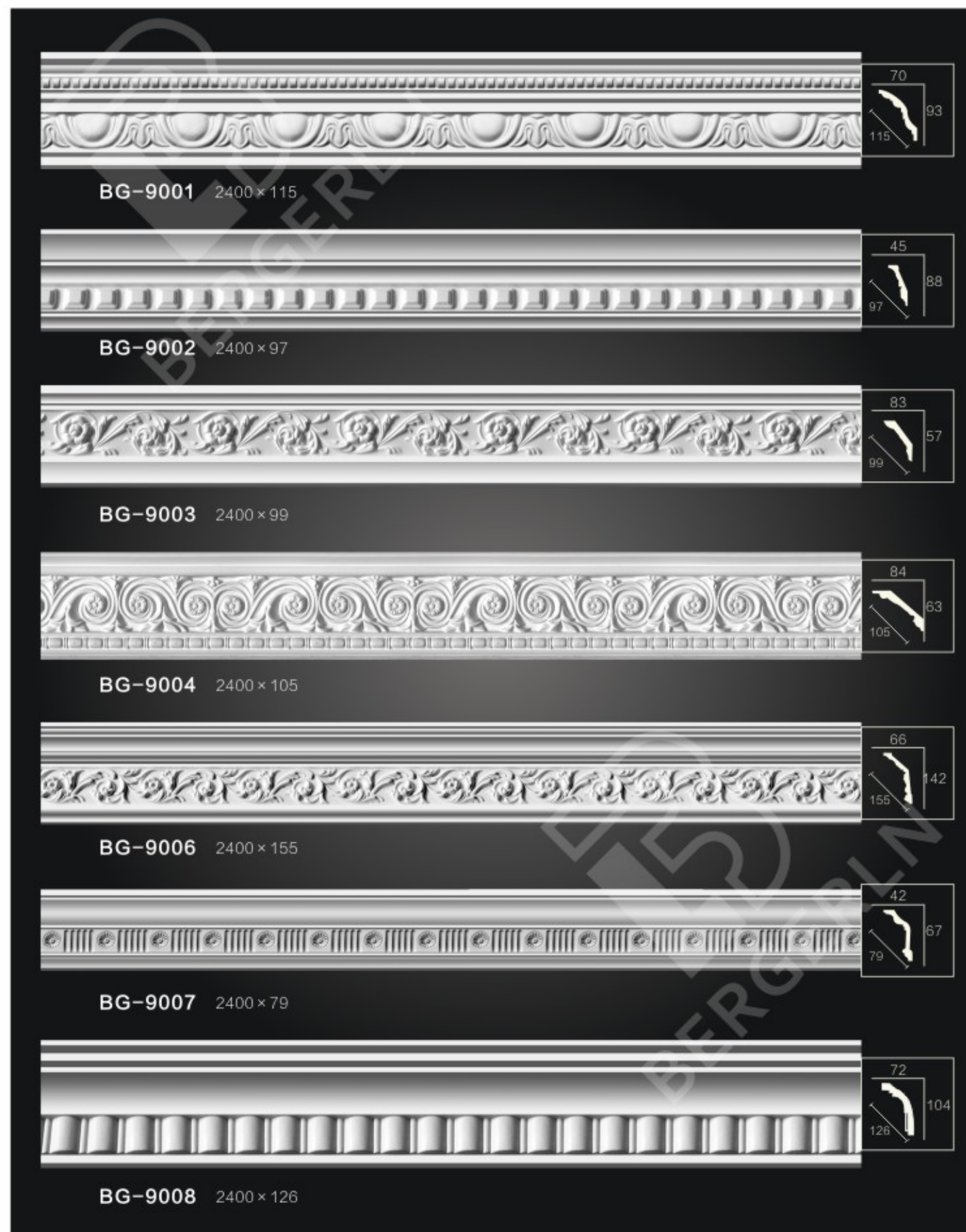

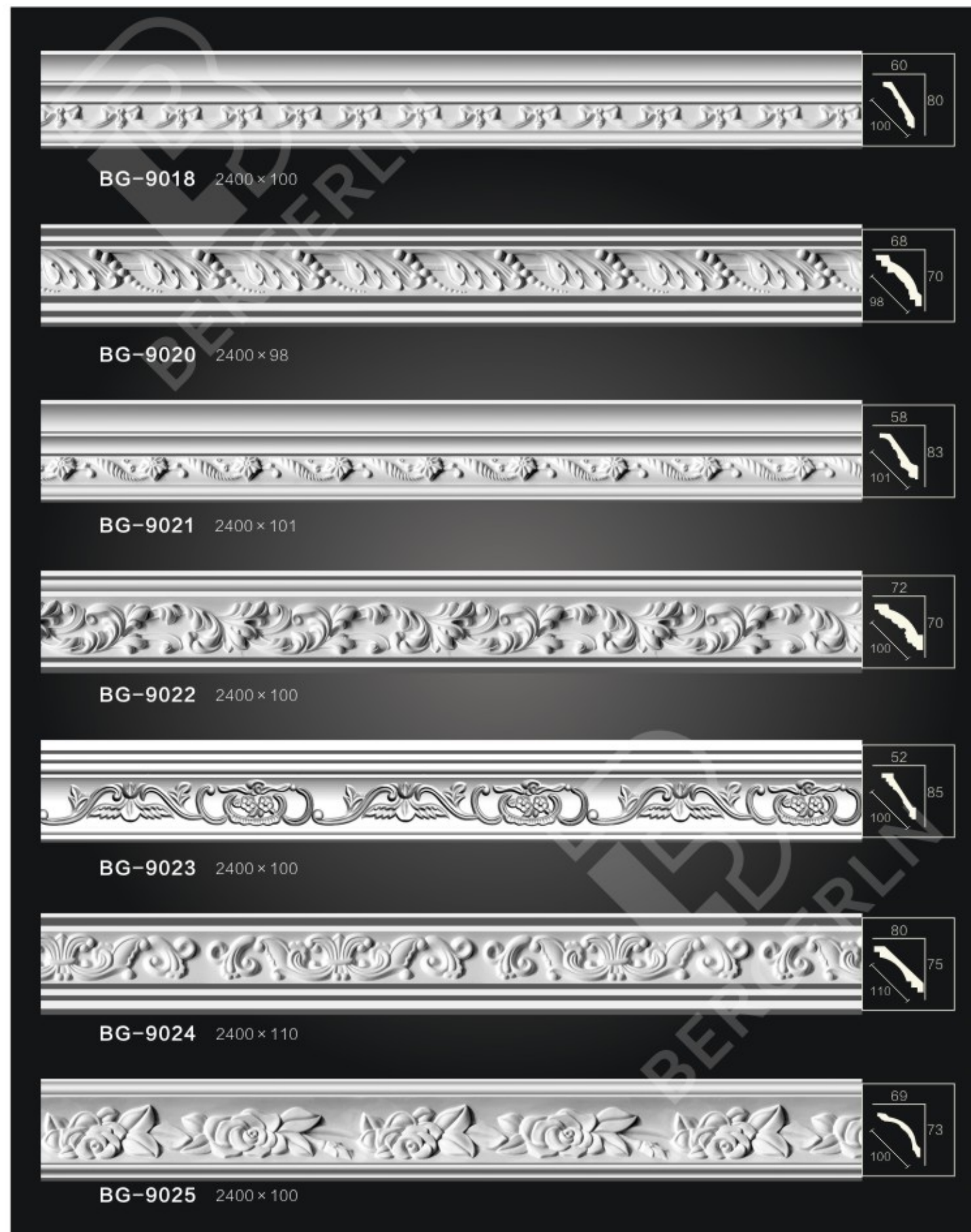



Size:mm

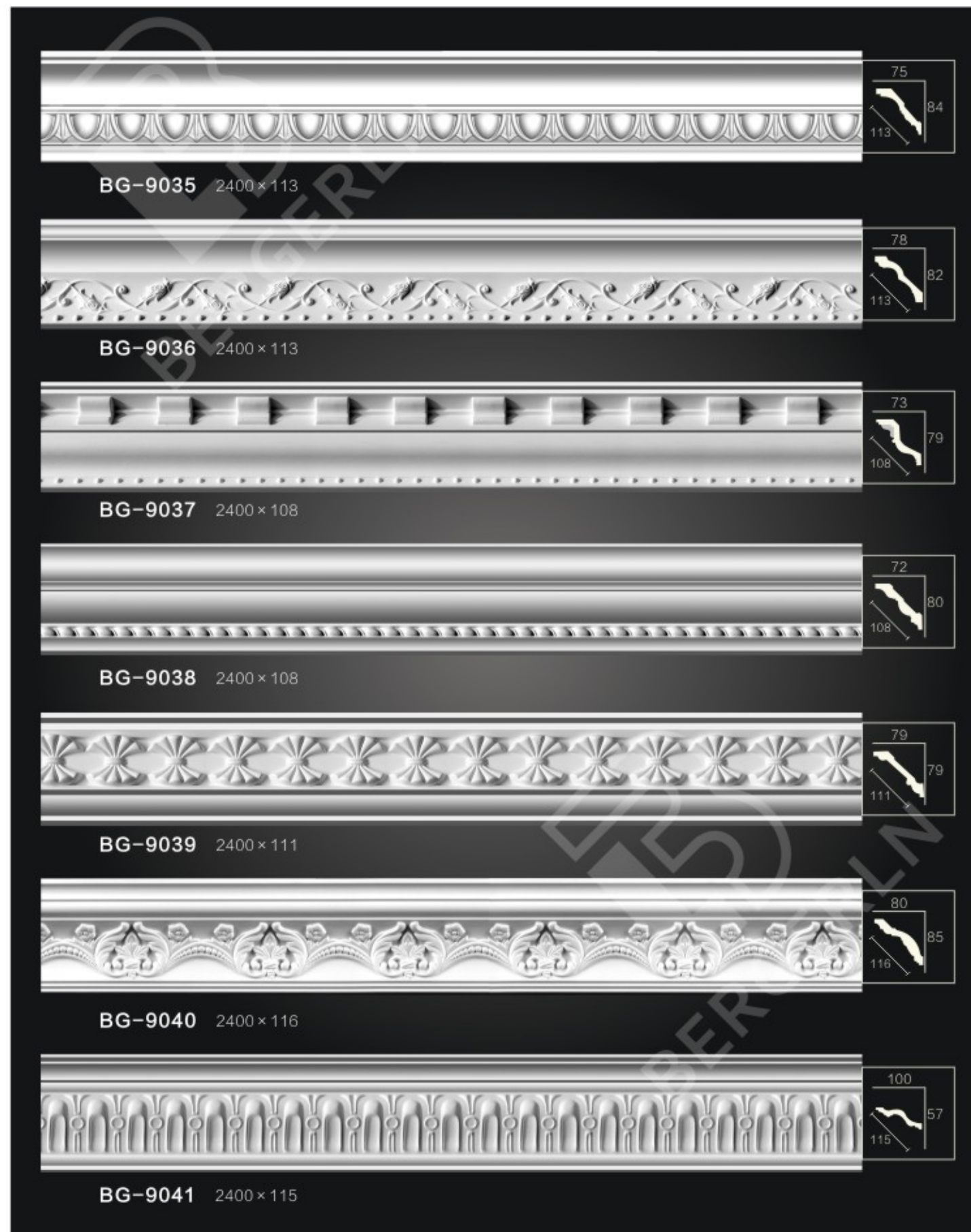

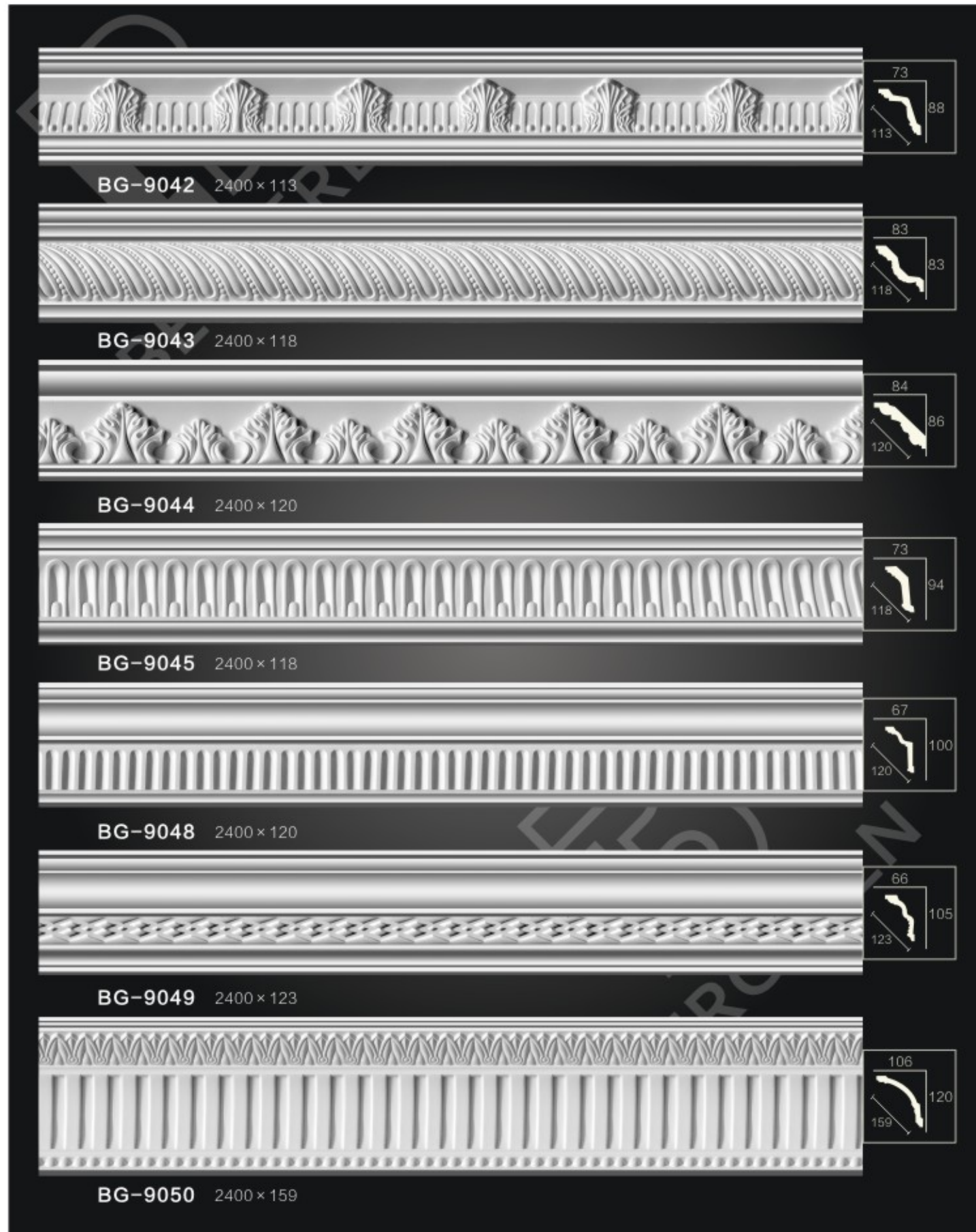

Size:mm

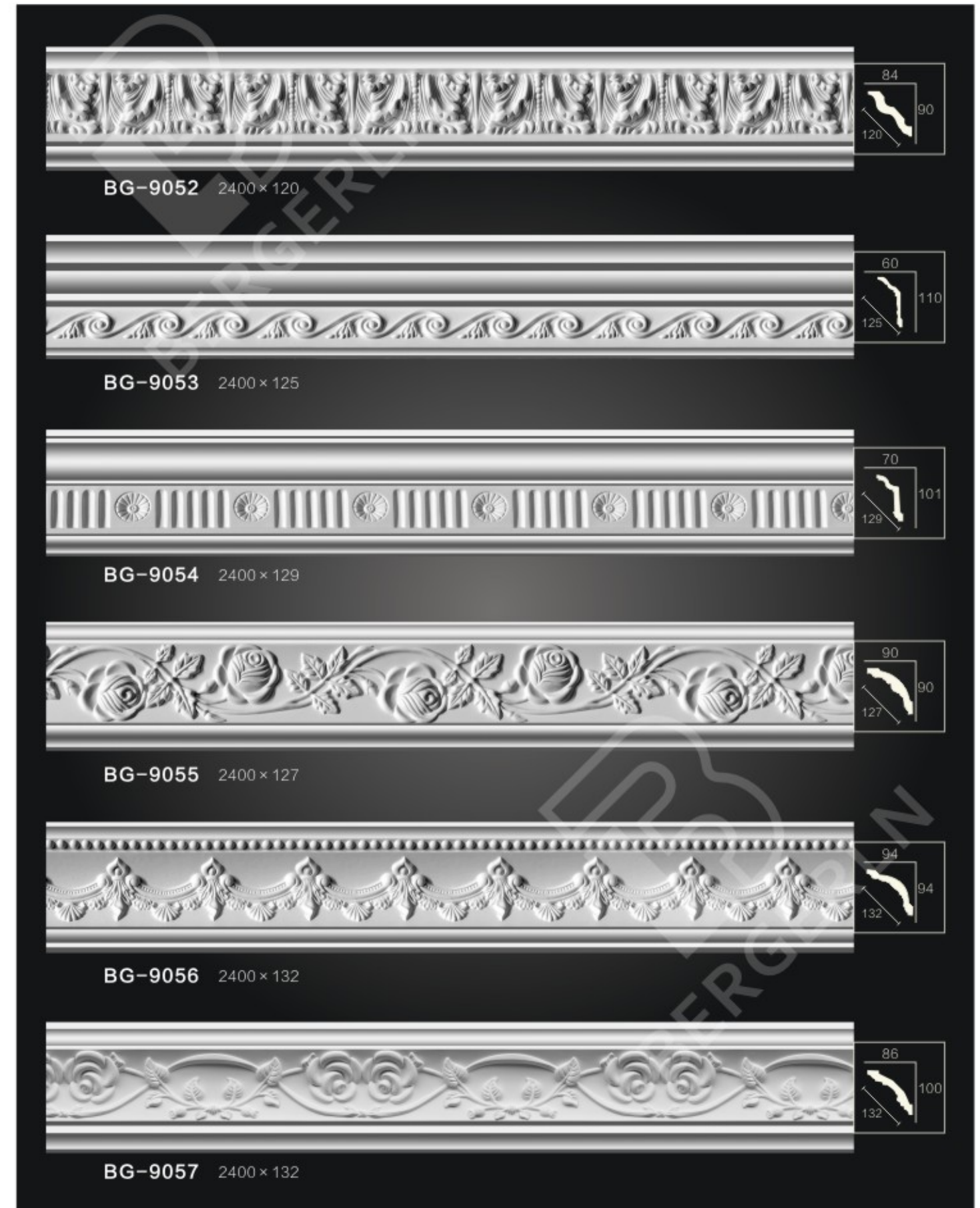

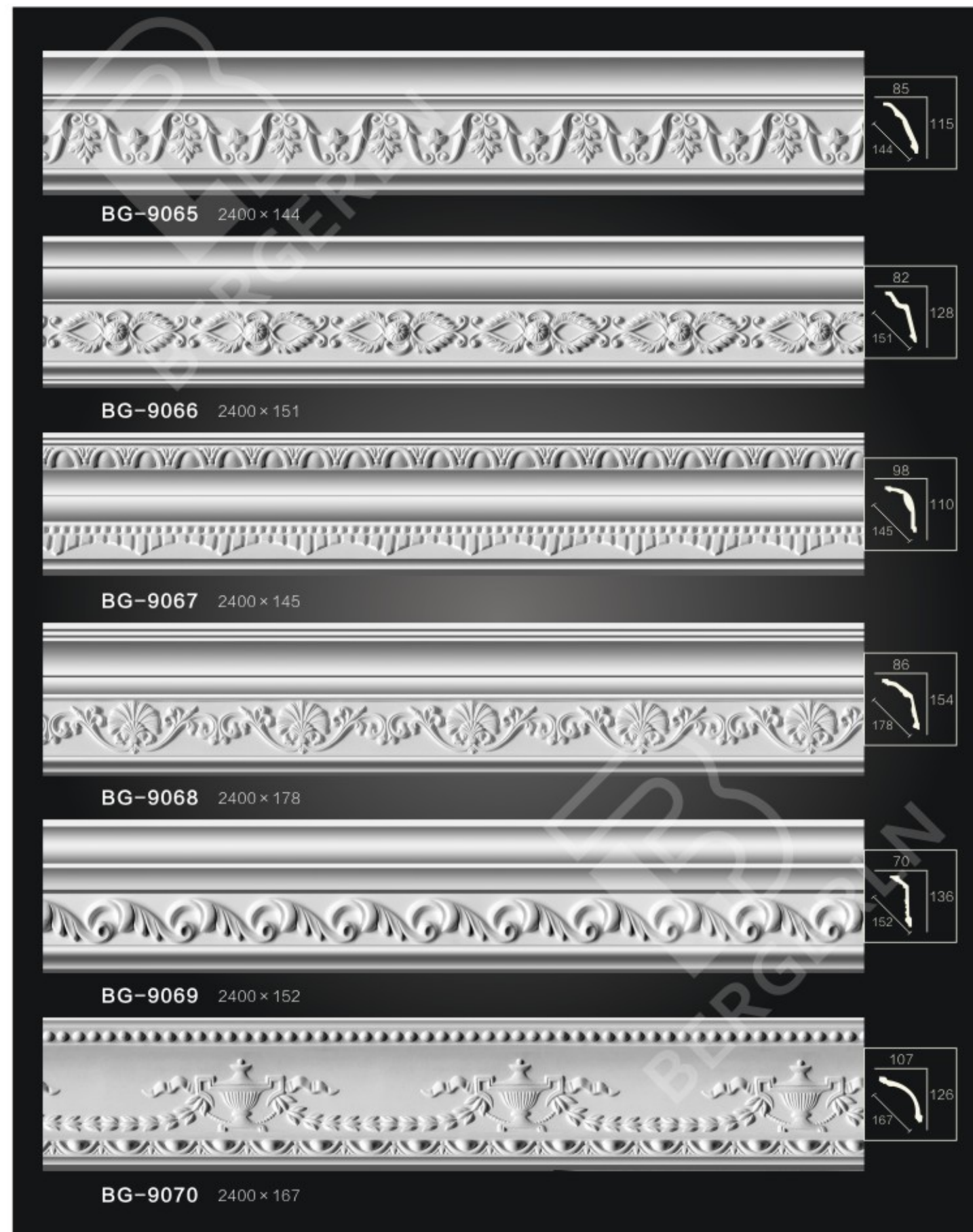
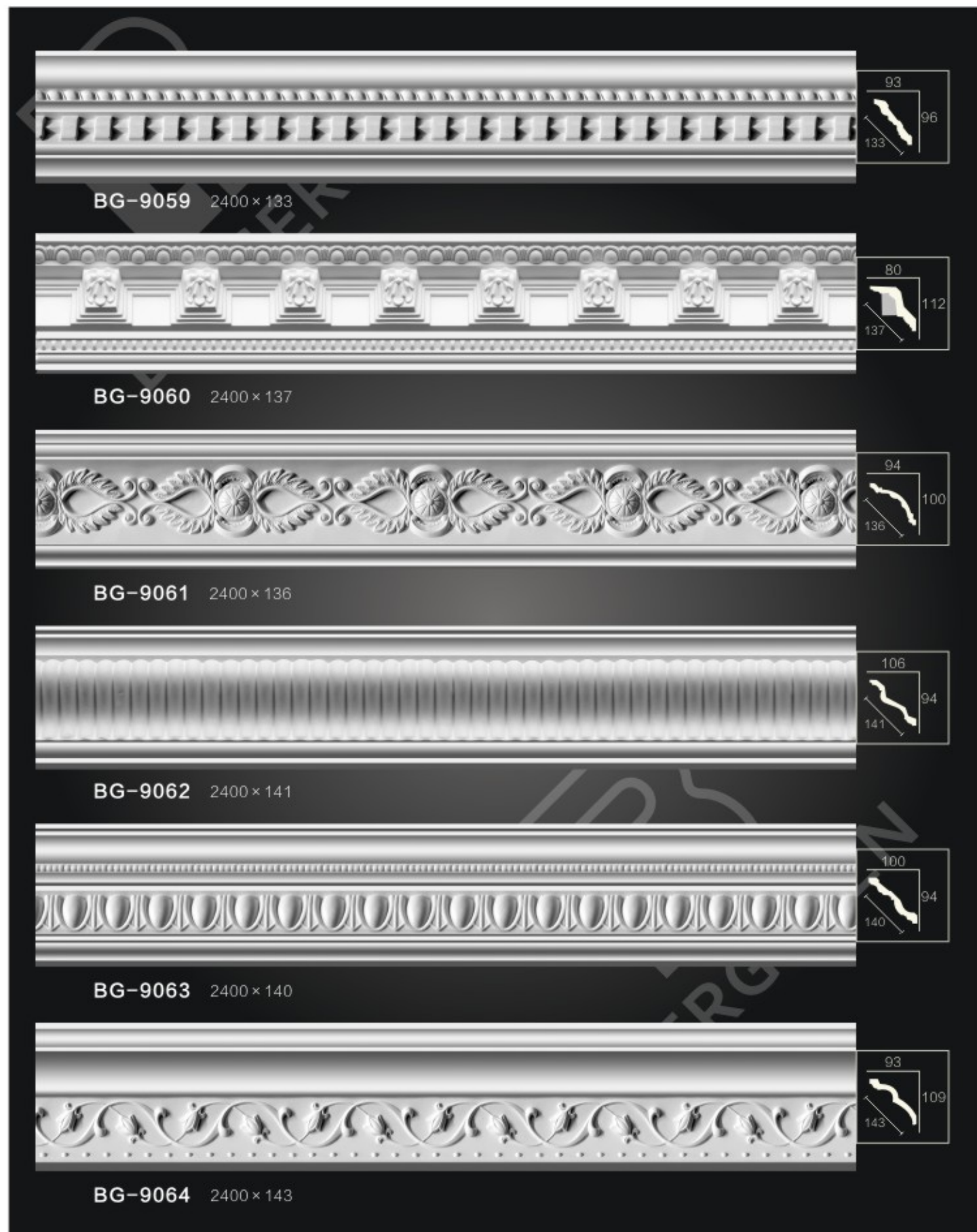

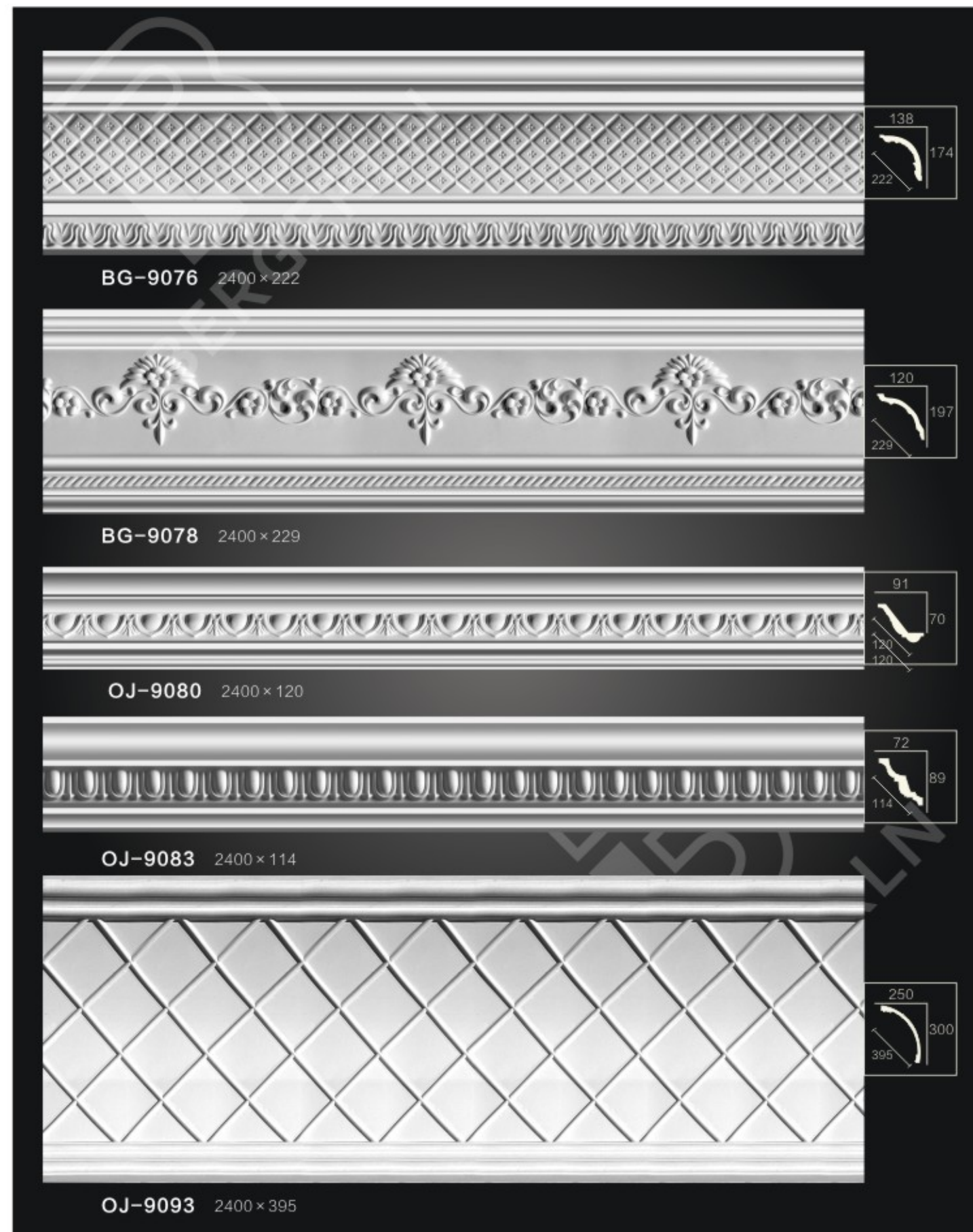
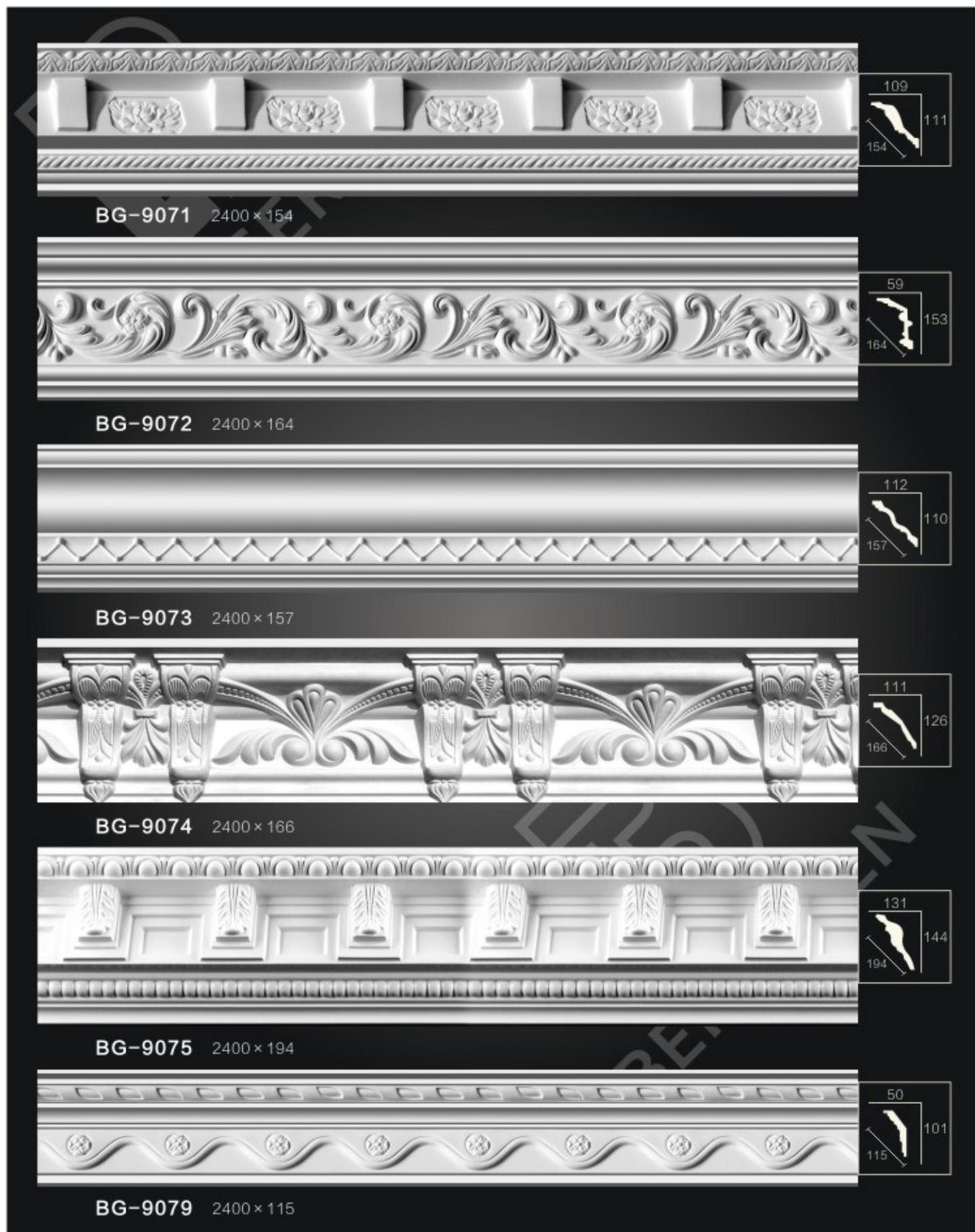

Size:mm

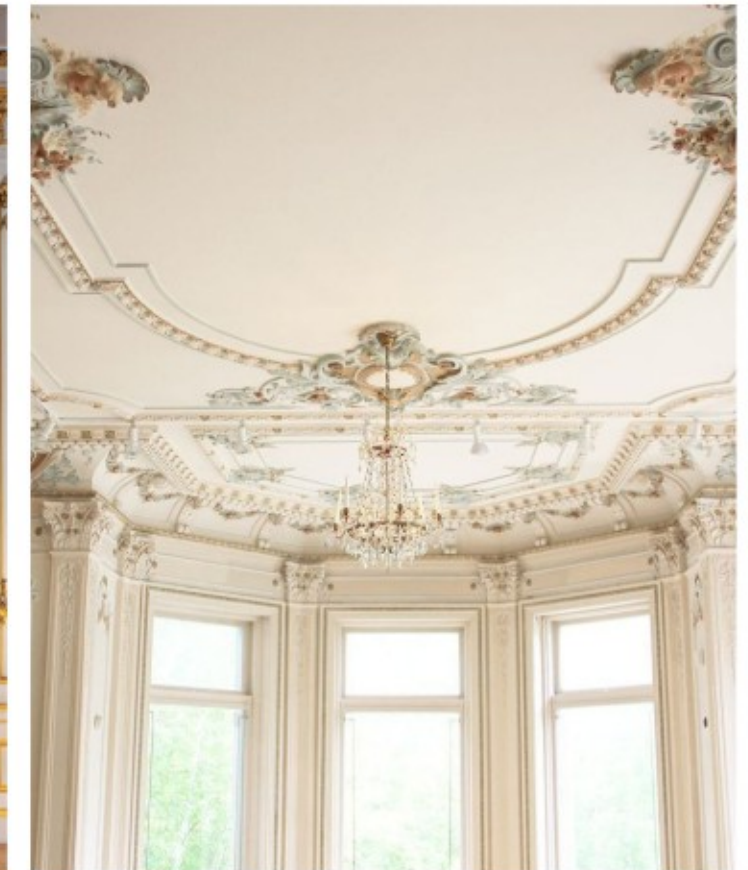
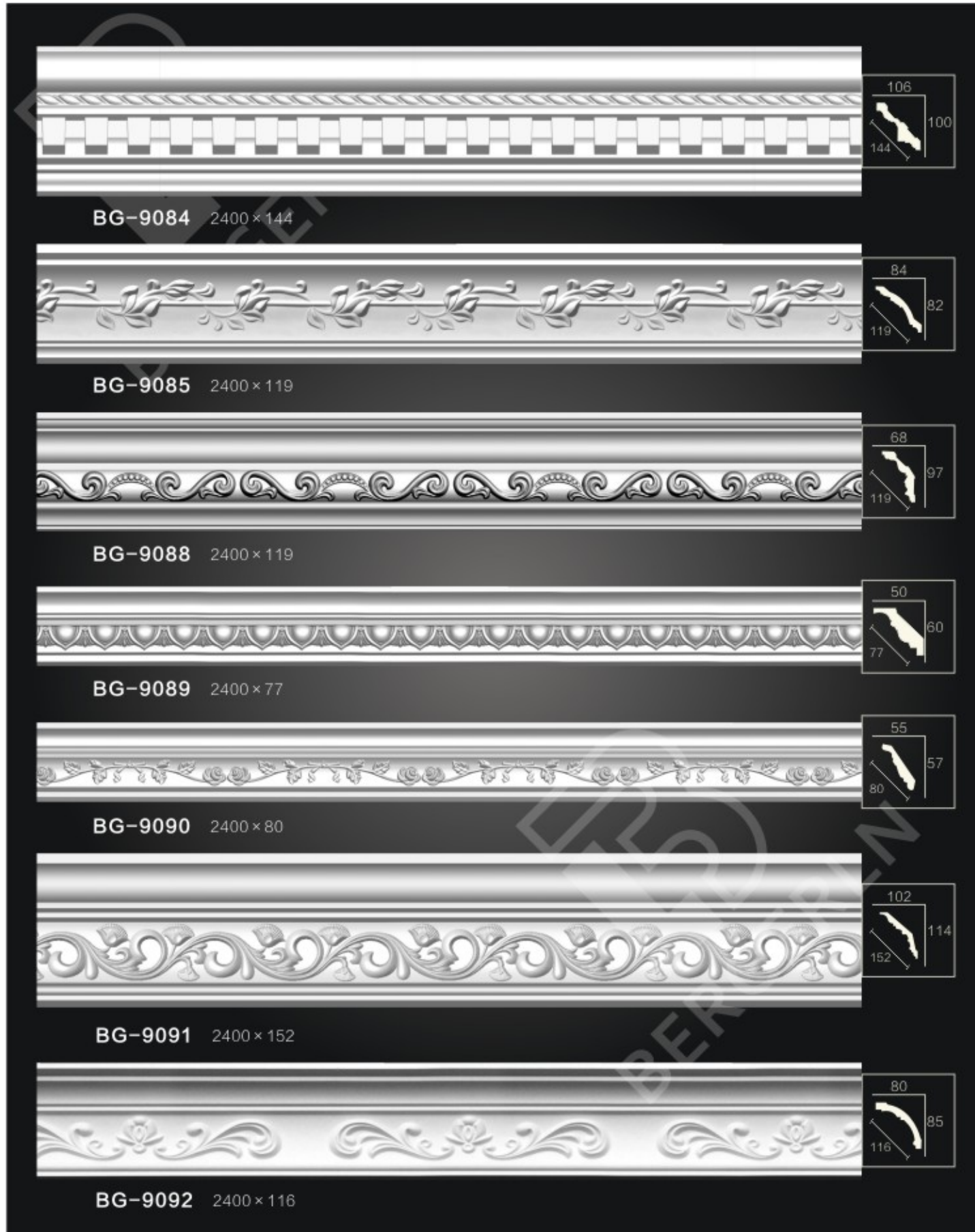

BERGERLN PU in the design stage, the craftsman spirit is reflected in the understanding and respect of culture and users; in the manufacturing stage, it is reflected in the inheritance and innovation of craft and technology. Home must have style, French charm, classical and modern atmosphere, super beautiful and charming!

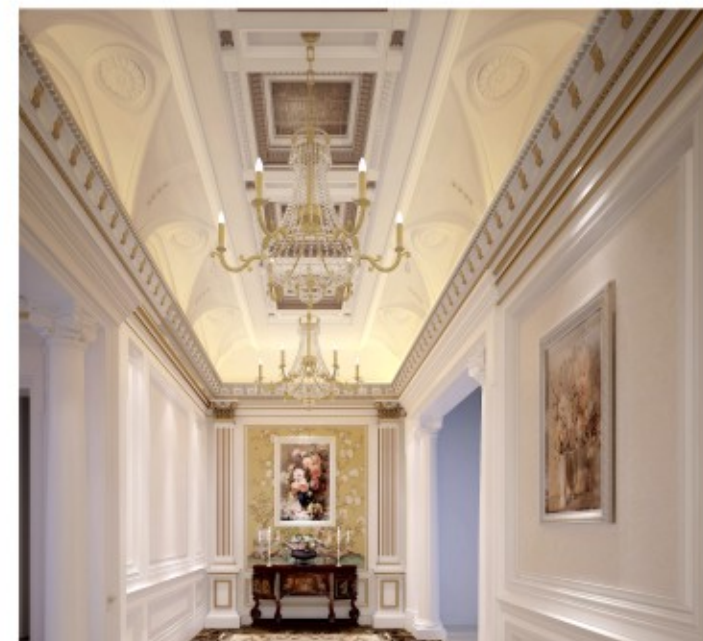

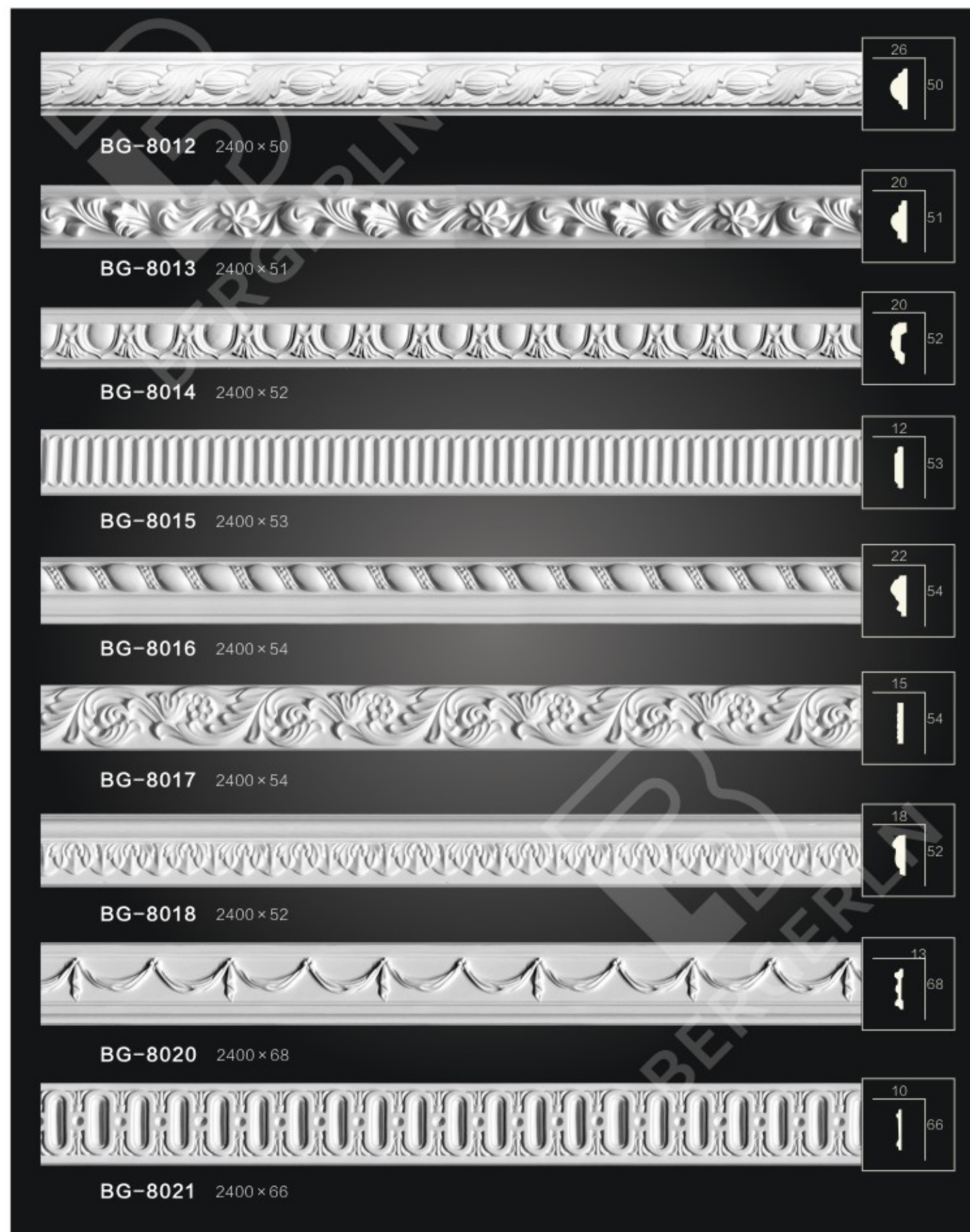
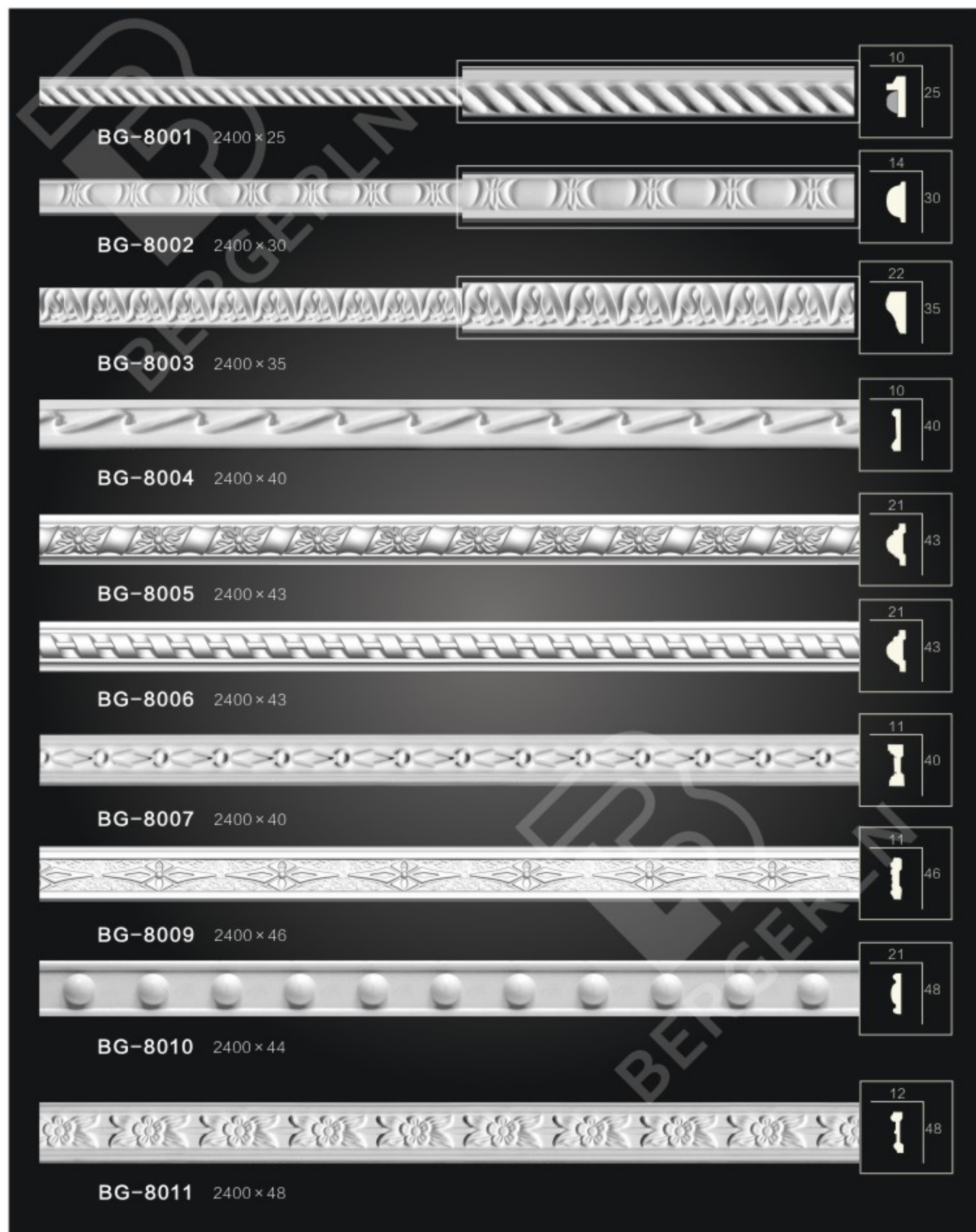

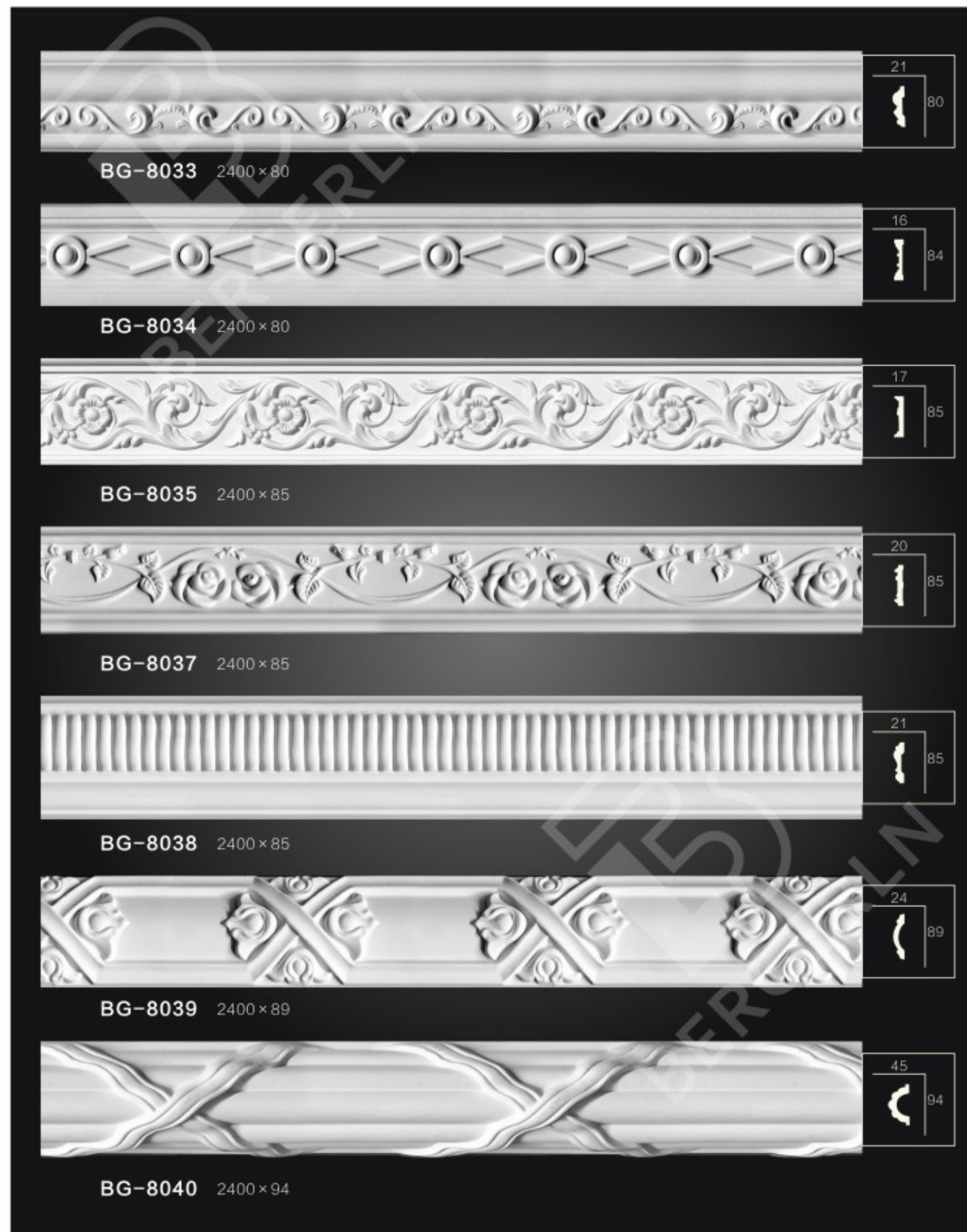
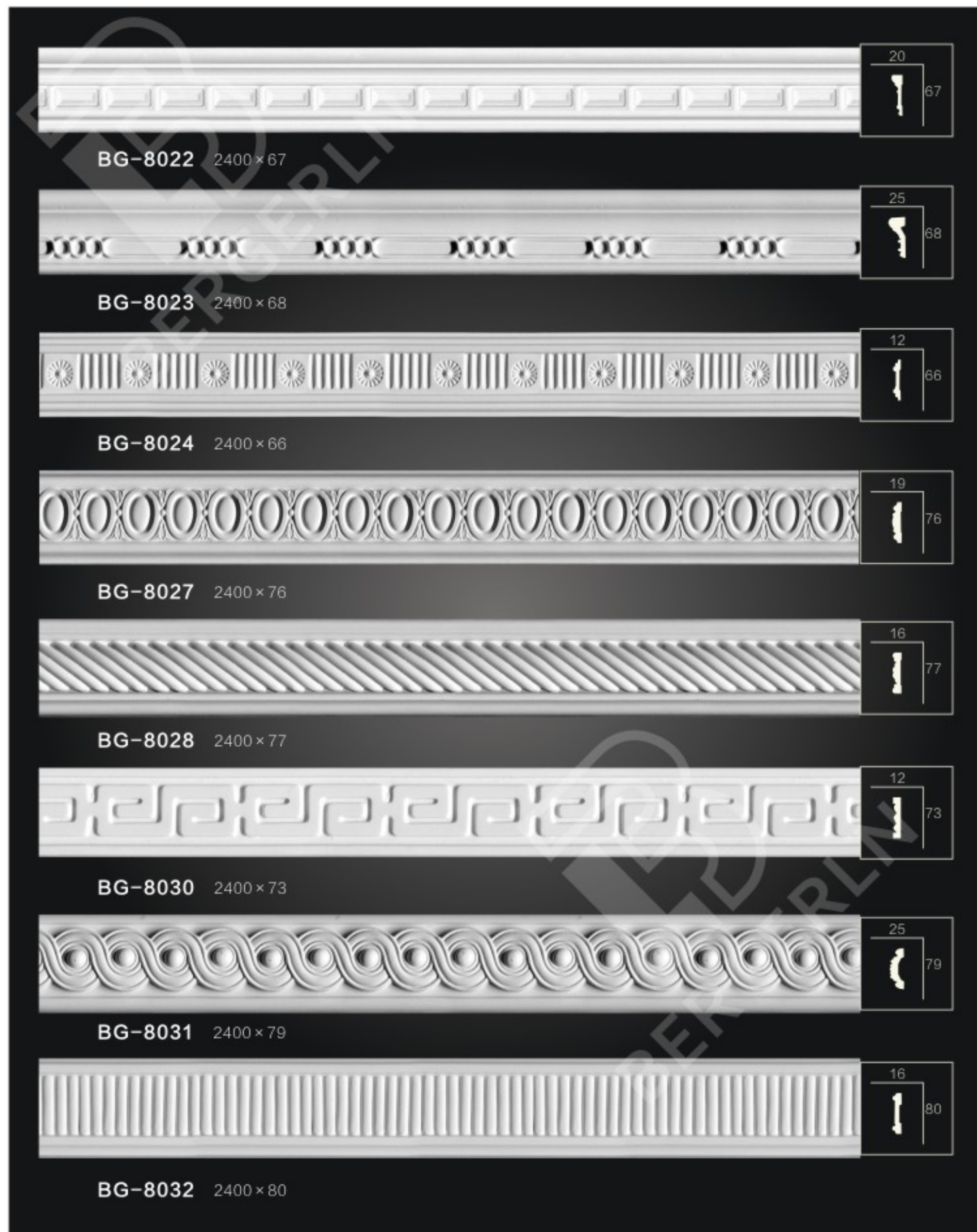



BG-8041 2400 x 96



BG-8042 2400 x 92



BG-8043 2400 x 93



BG-8044 2400 x 99



BG-8045 2400 x 101

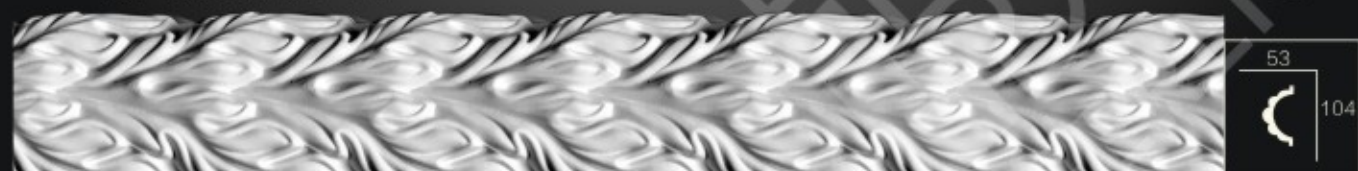

BG-8047 2400 x 104



BG-8049 2400 x 105

Size:mm



BG-8051 2400 x 107



BG-8052 2400 x 112



BG-8053 2400 x 112



BG-8054 2400 x 111



BG-8055 2400 x 111



BG-8057 2400 x 123

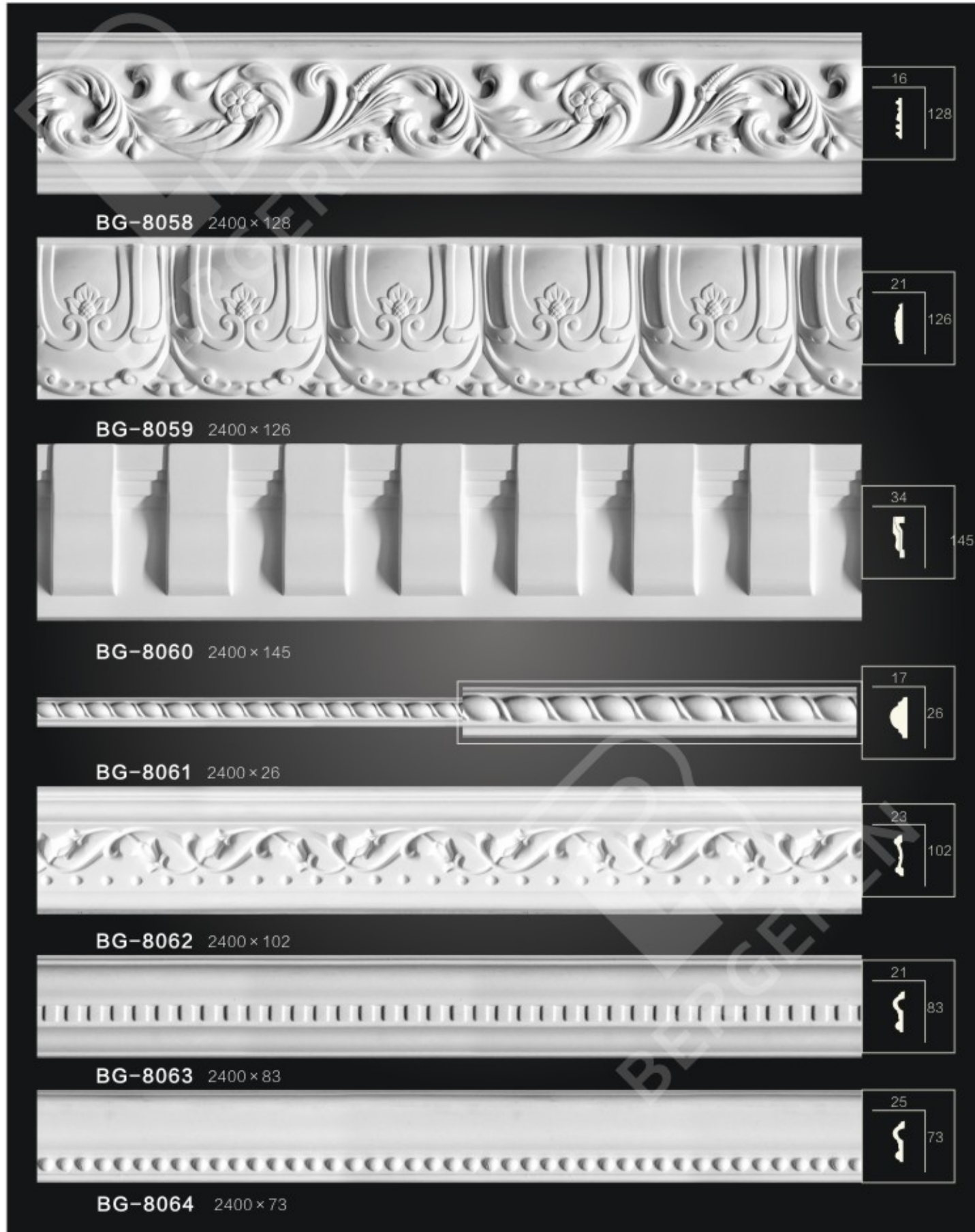

Size:mm





Size:mm







Size:mm

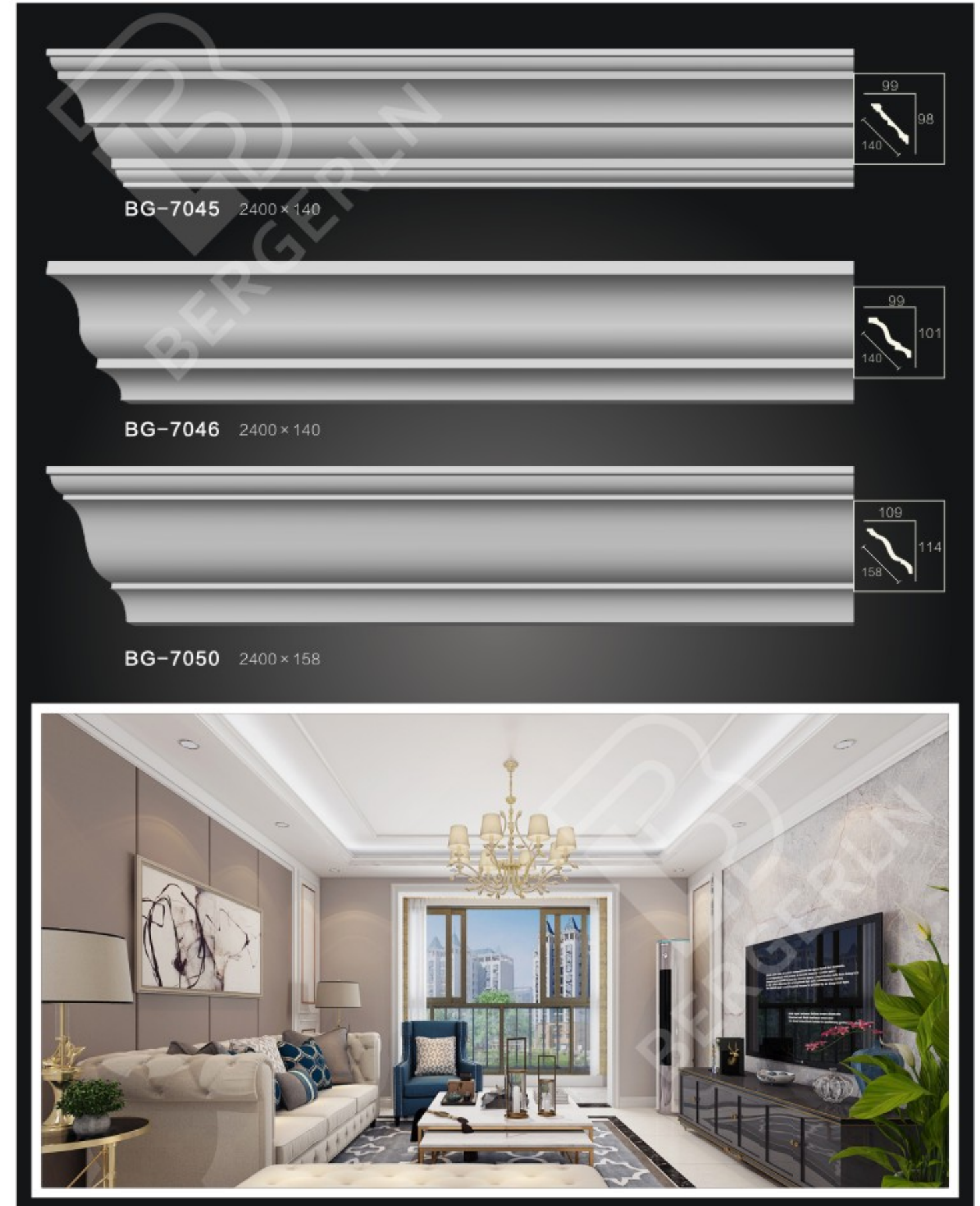

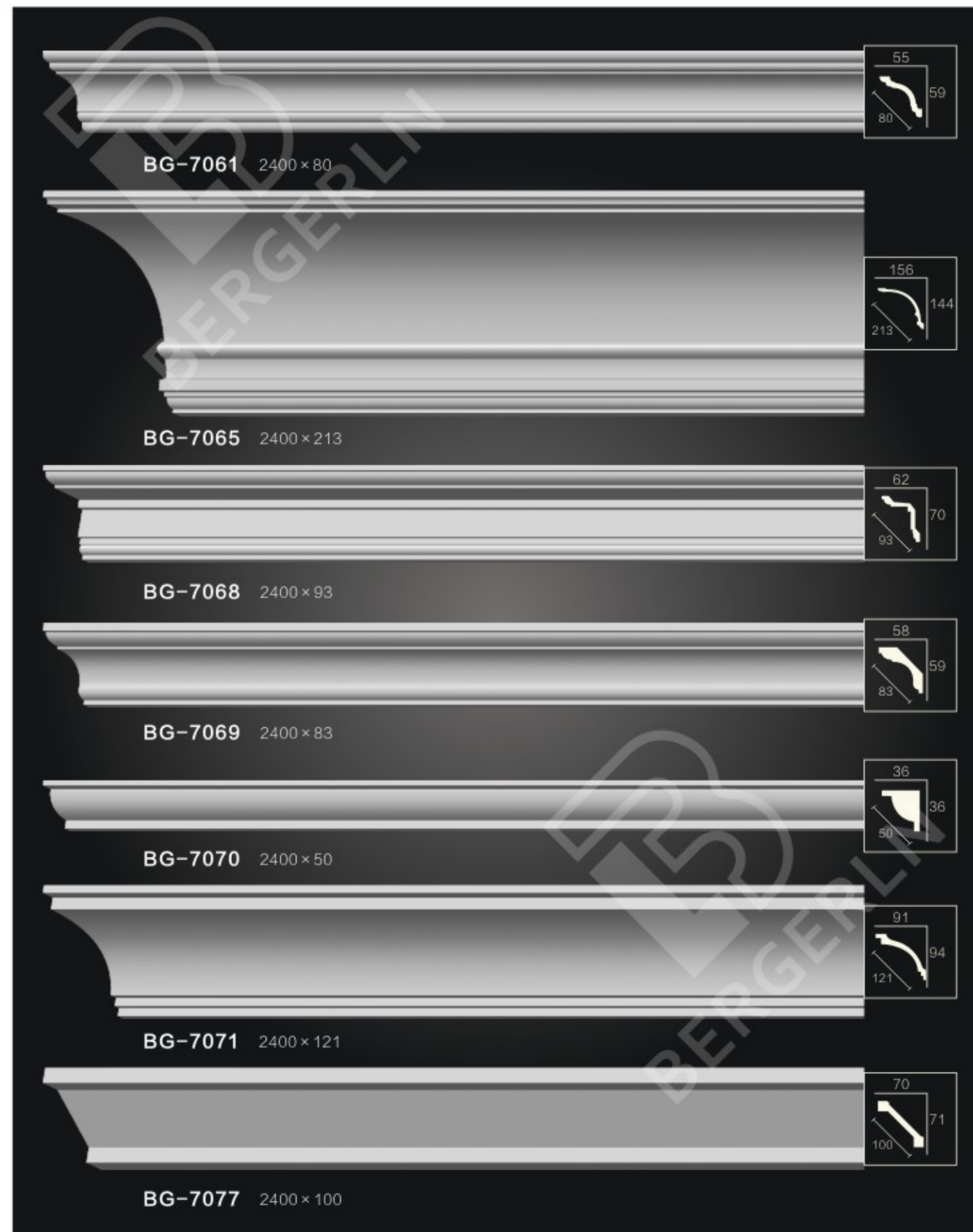









Size:mm

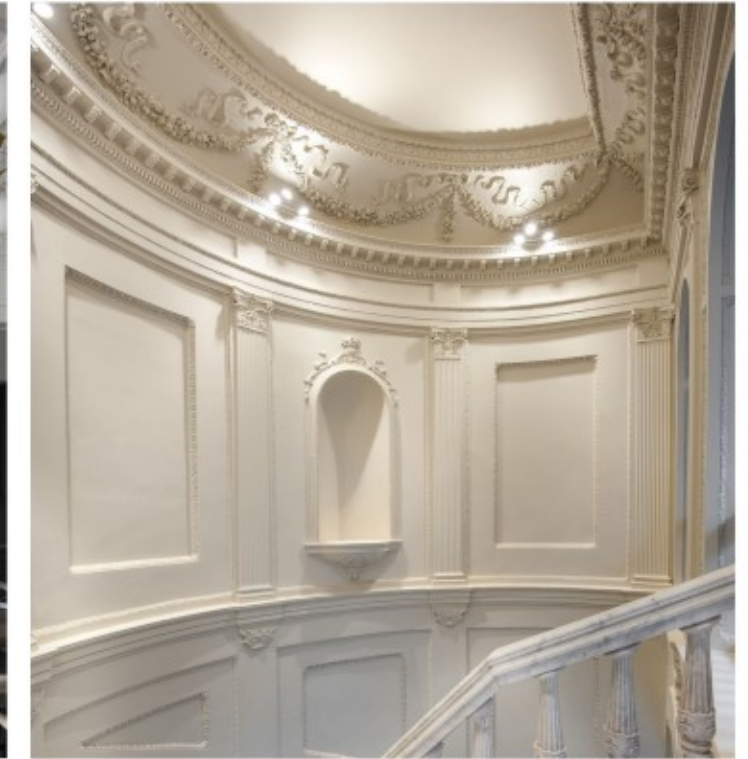

BERGERLN PU during the installation process, infrared instruments must be used to adjust the position of the flat, fixed lines on the wall. Note: 1. If there is a finished product corner, the corner must be installed first, and then the straight line. 2, where there is gypsum board or wooden keel, must be fixed with self-tapping screws, and do a good job of anti-rust treatment; 3. In the joint, reserve 10-15mm clearance as part of the seam filling slot.



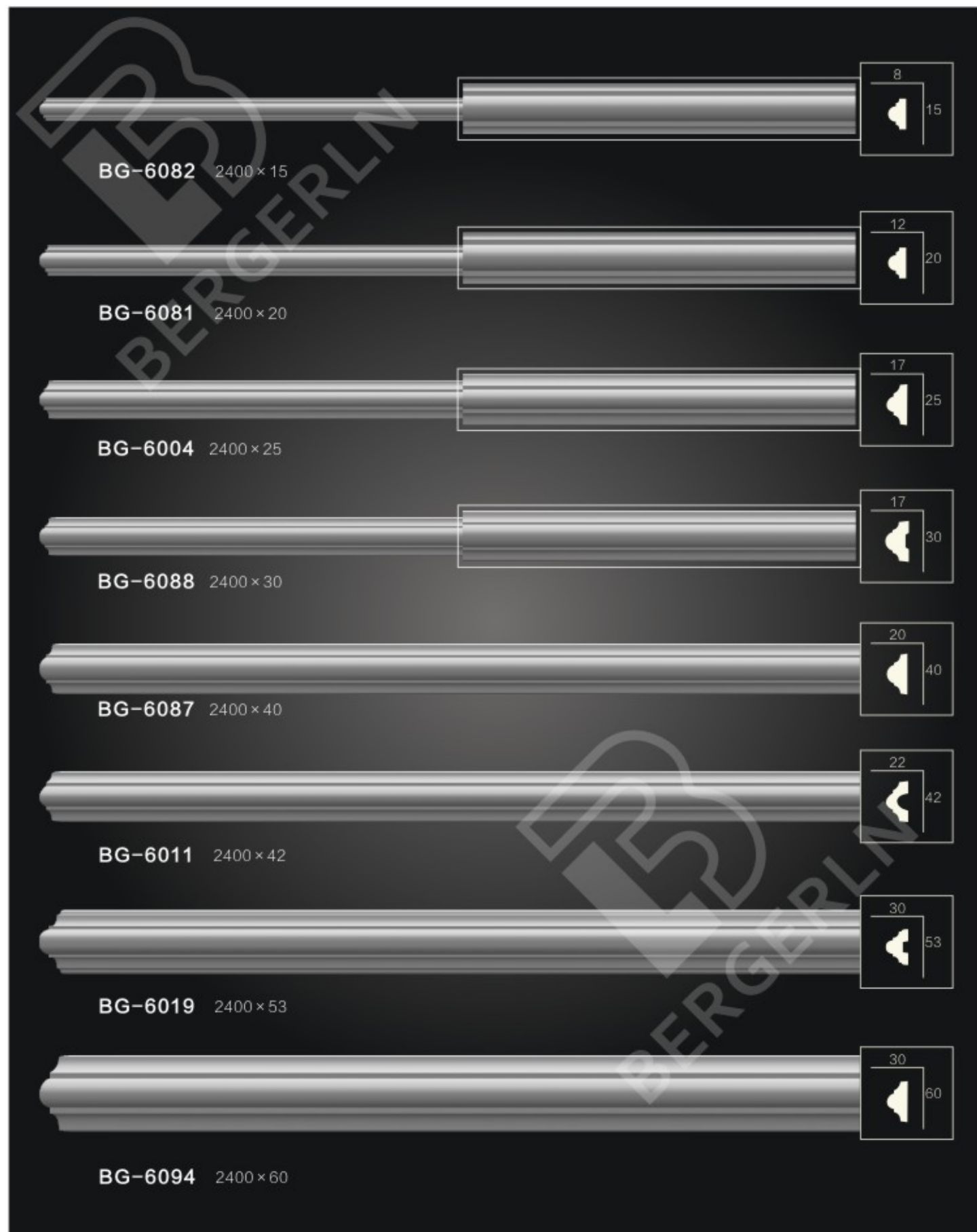

Size:mm

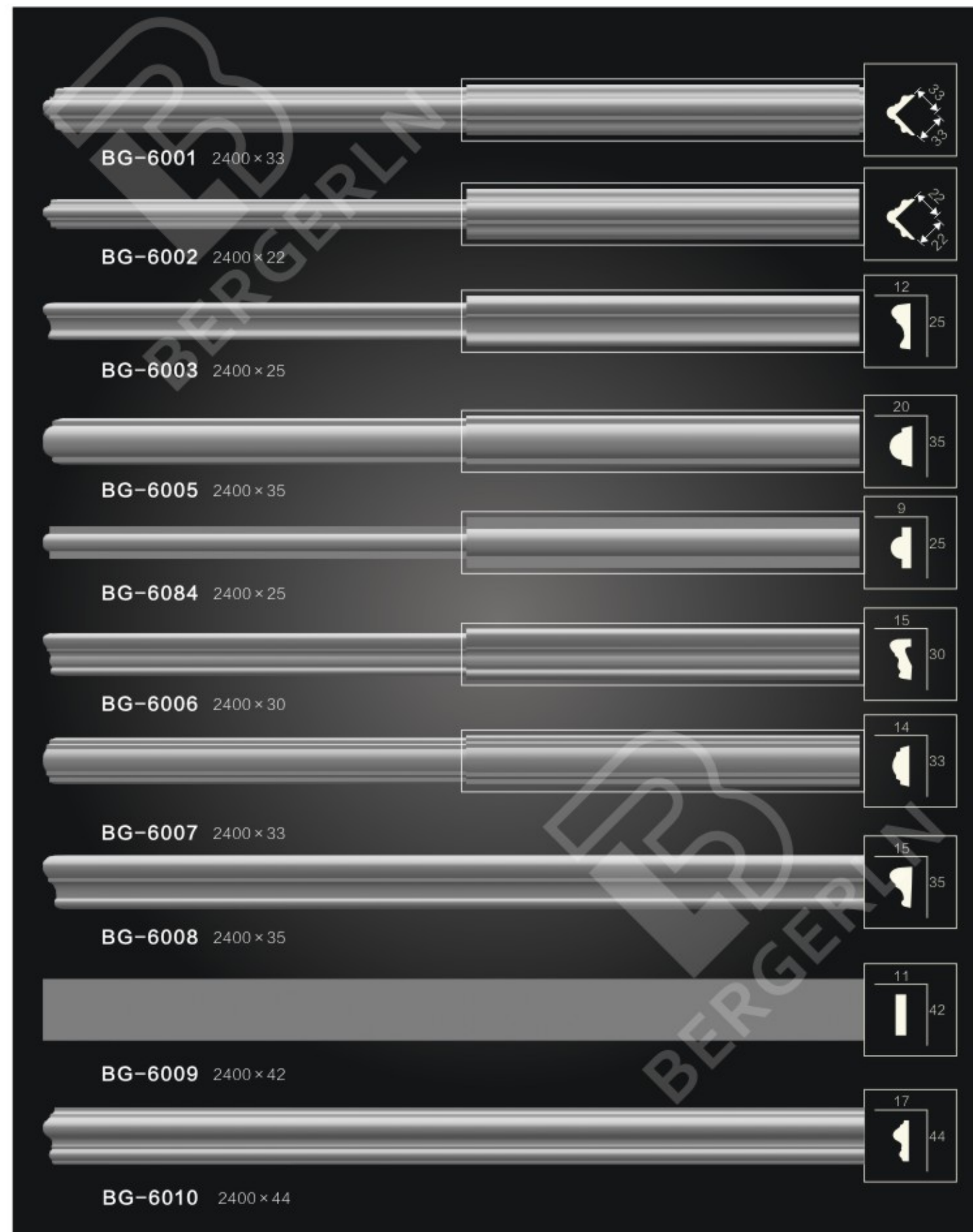

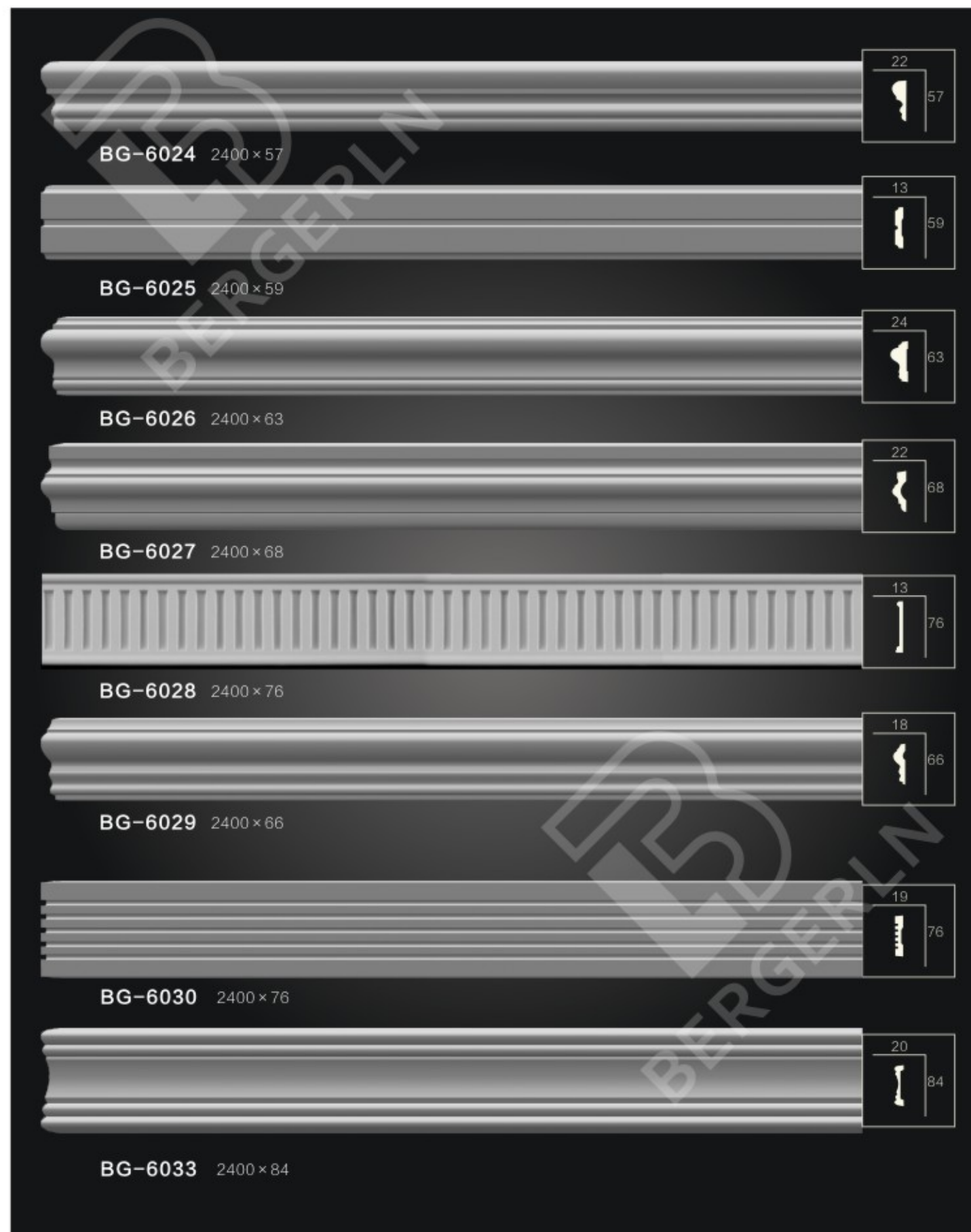







Size:mm

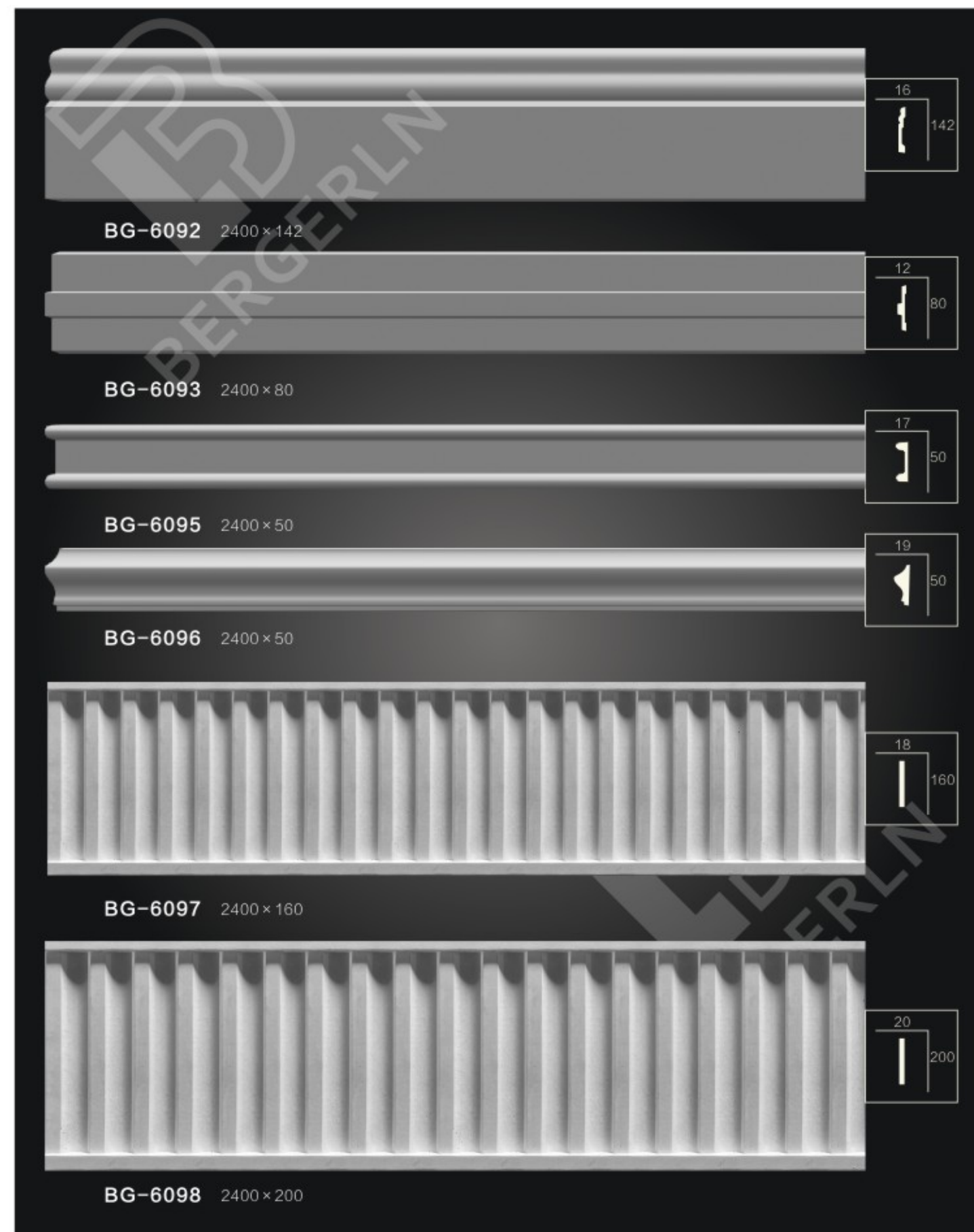

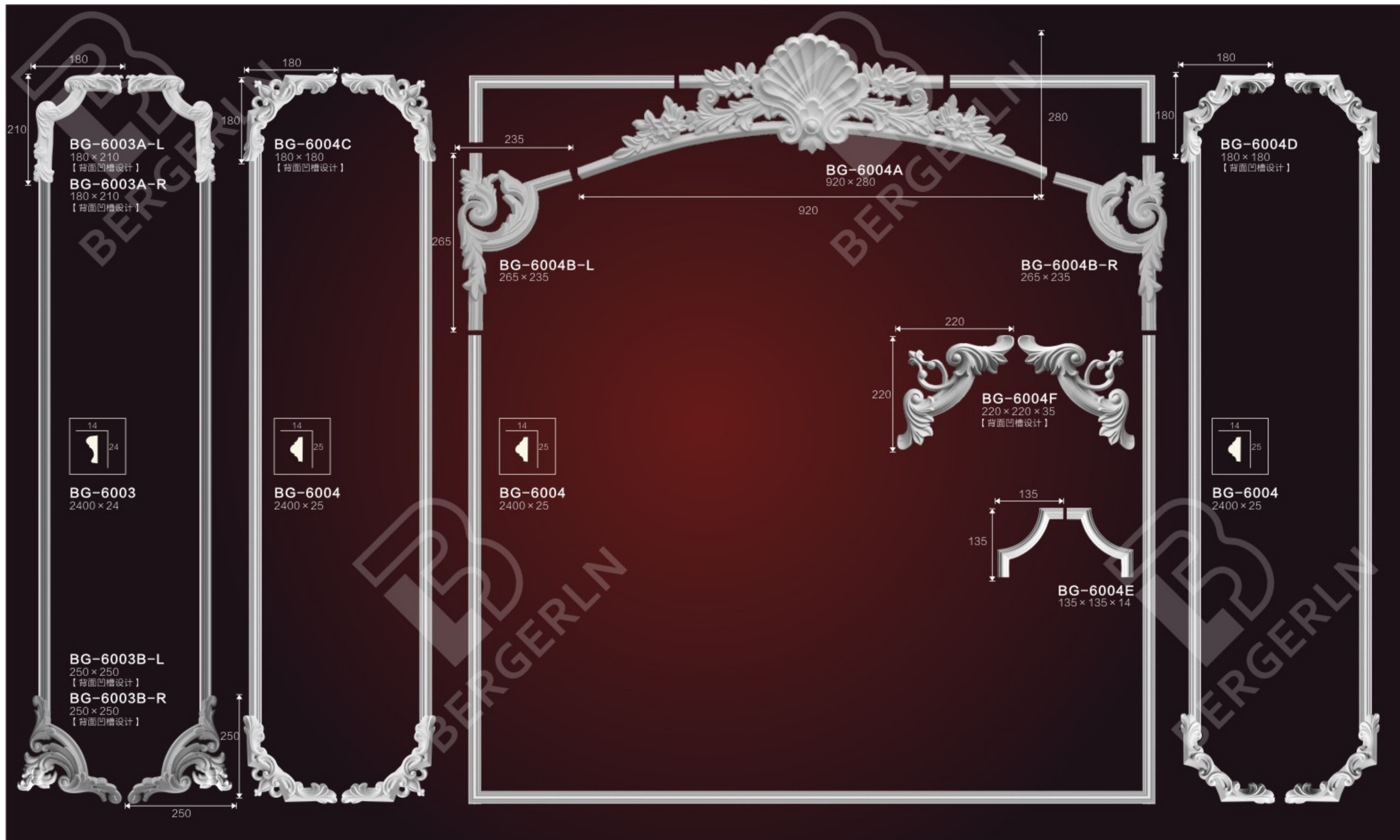

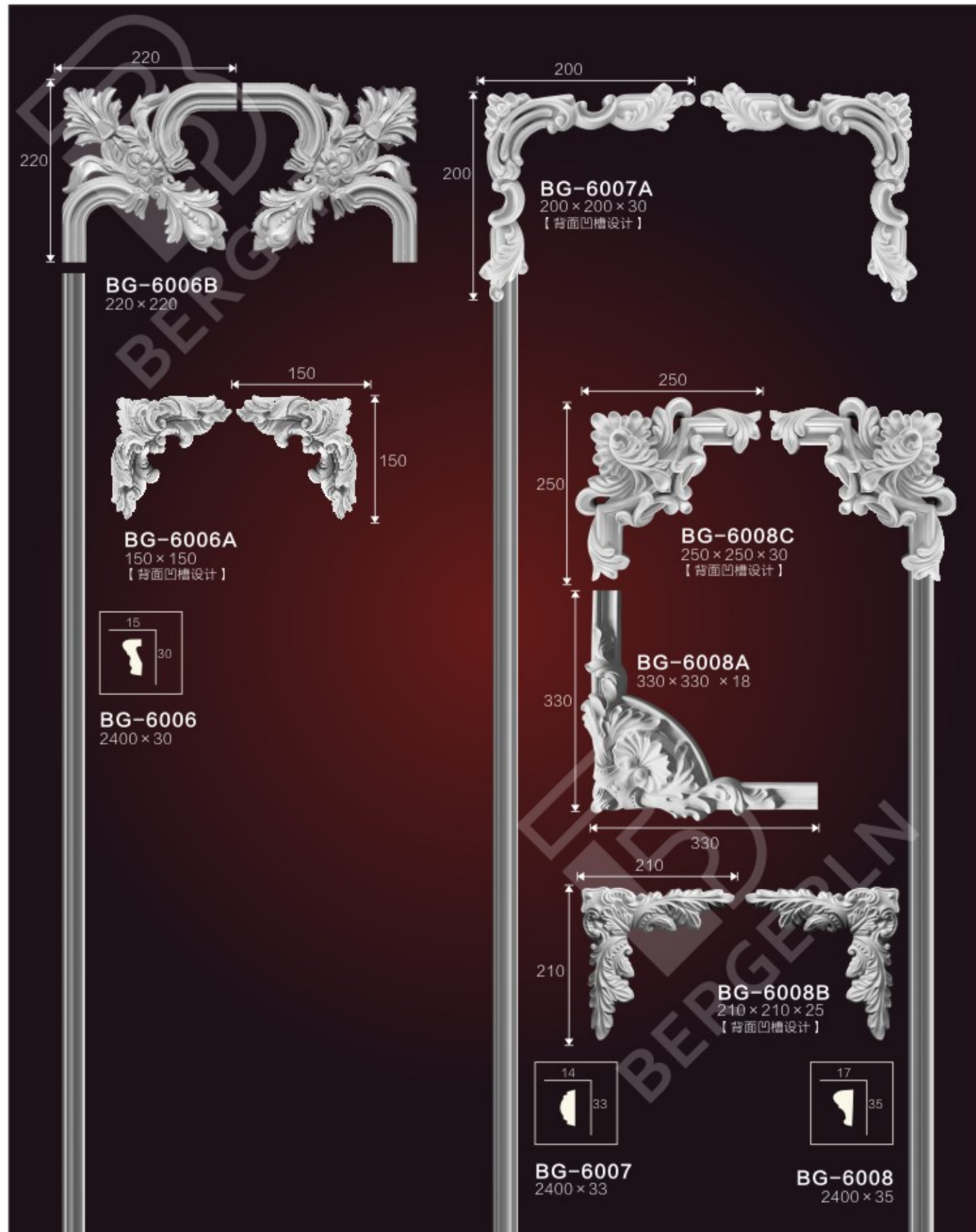

Size:mm

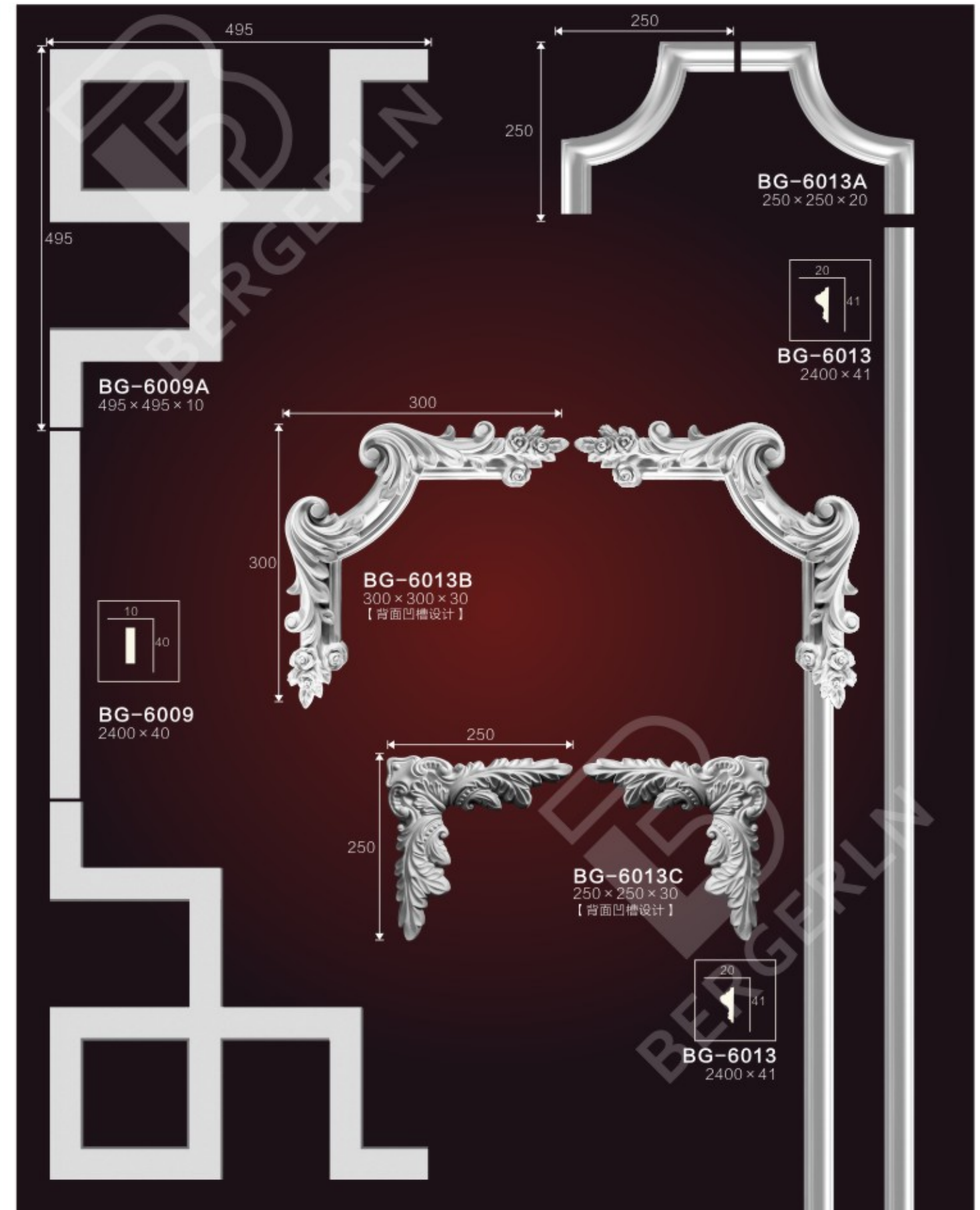

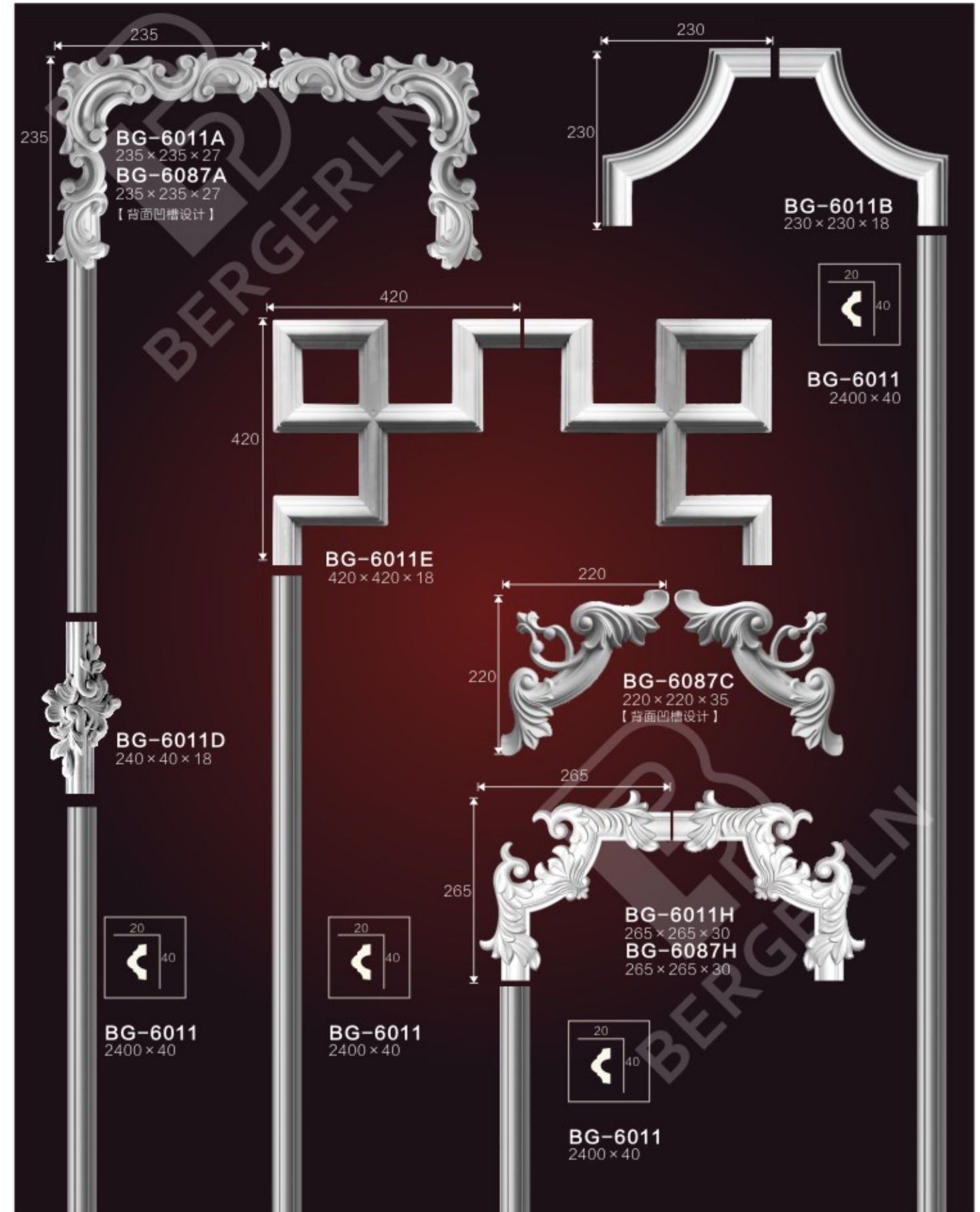
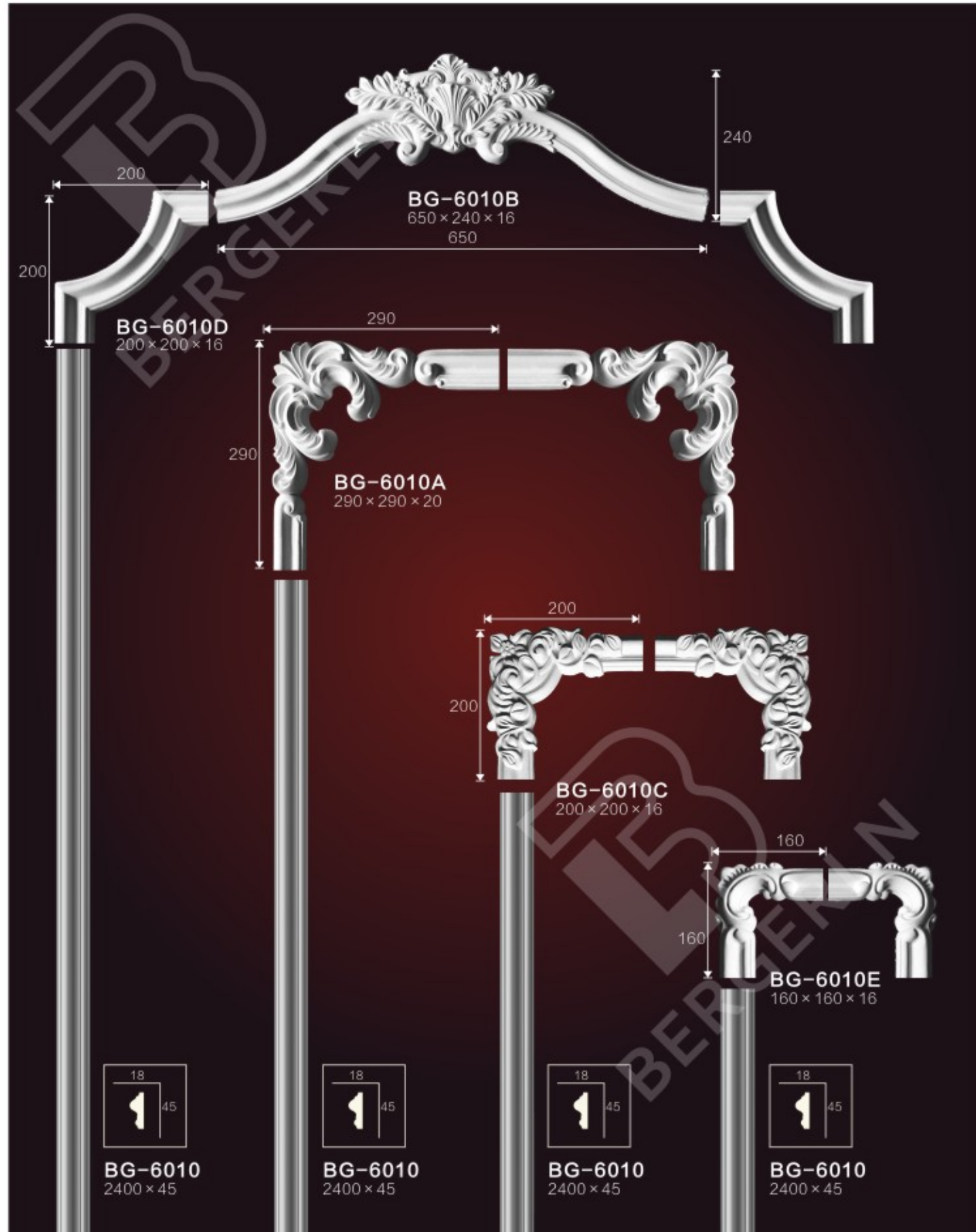

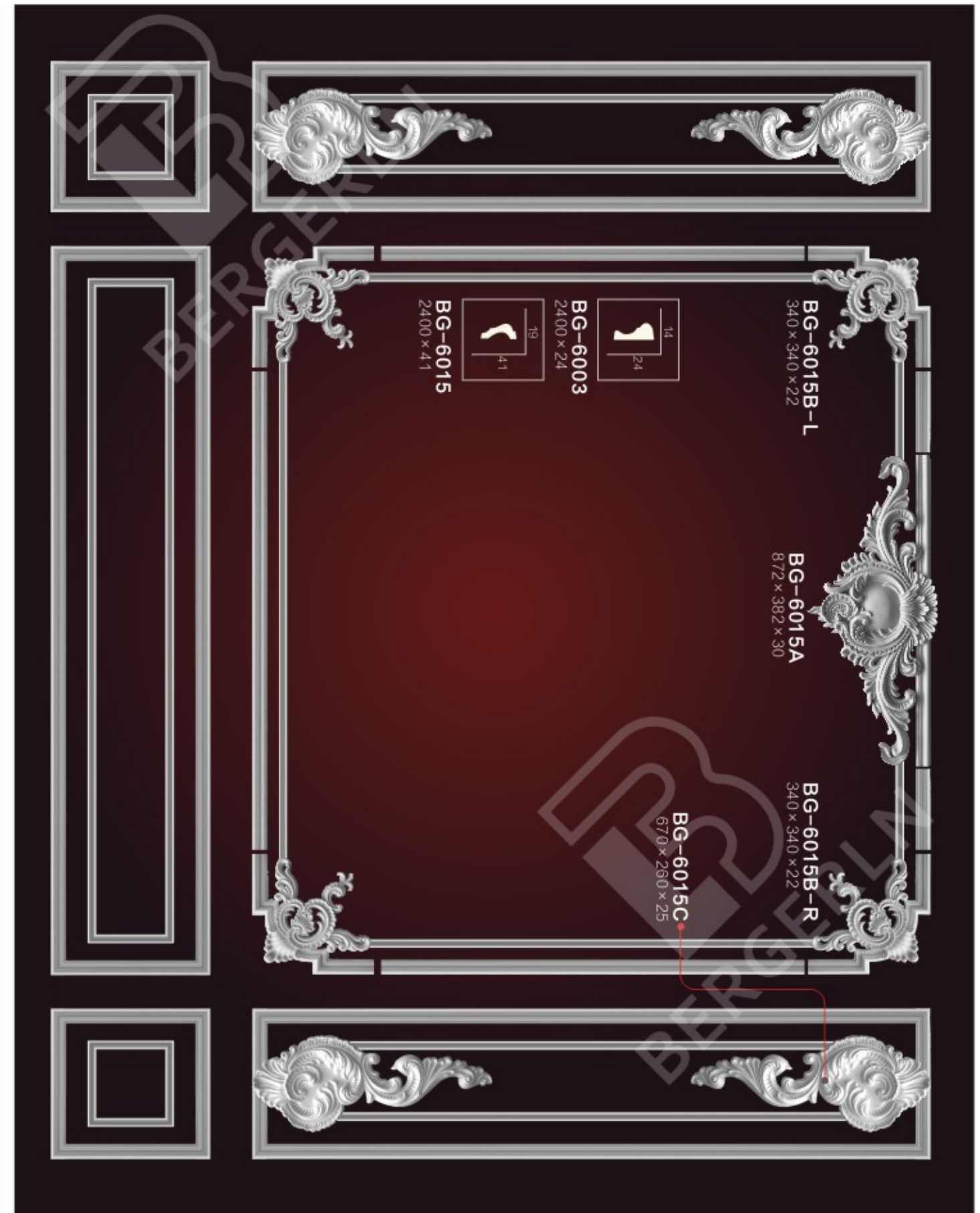
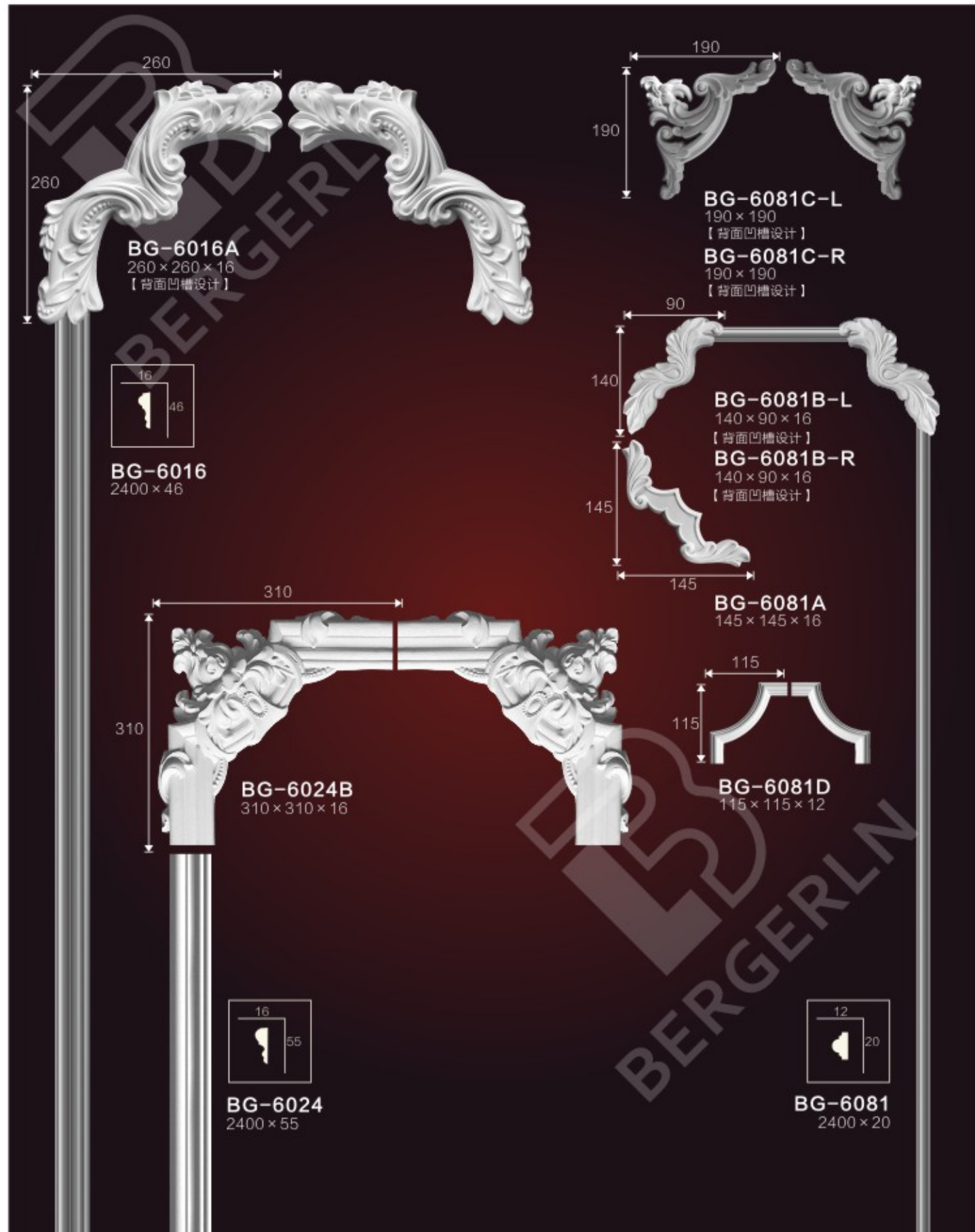

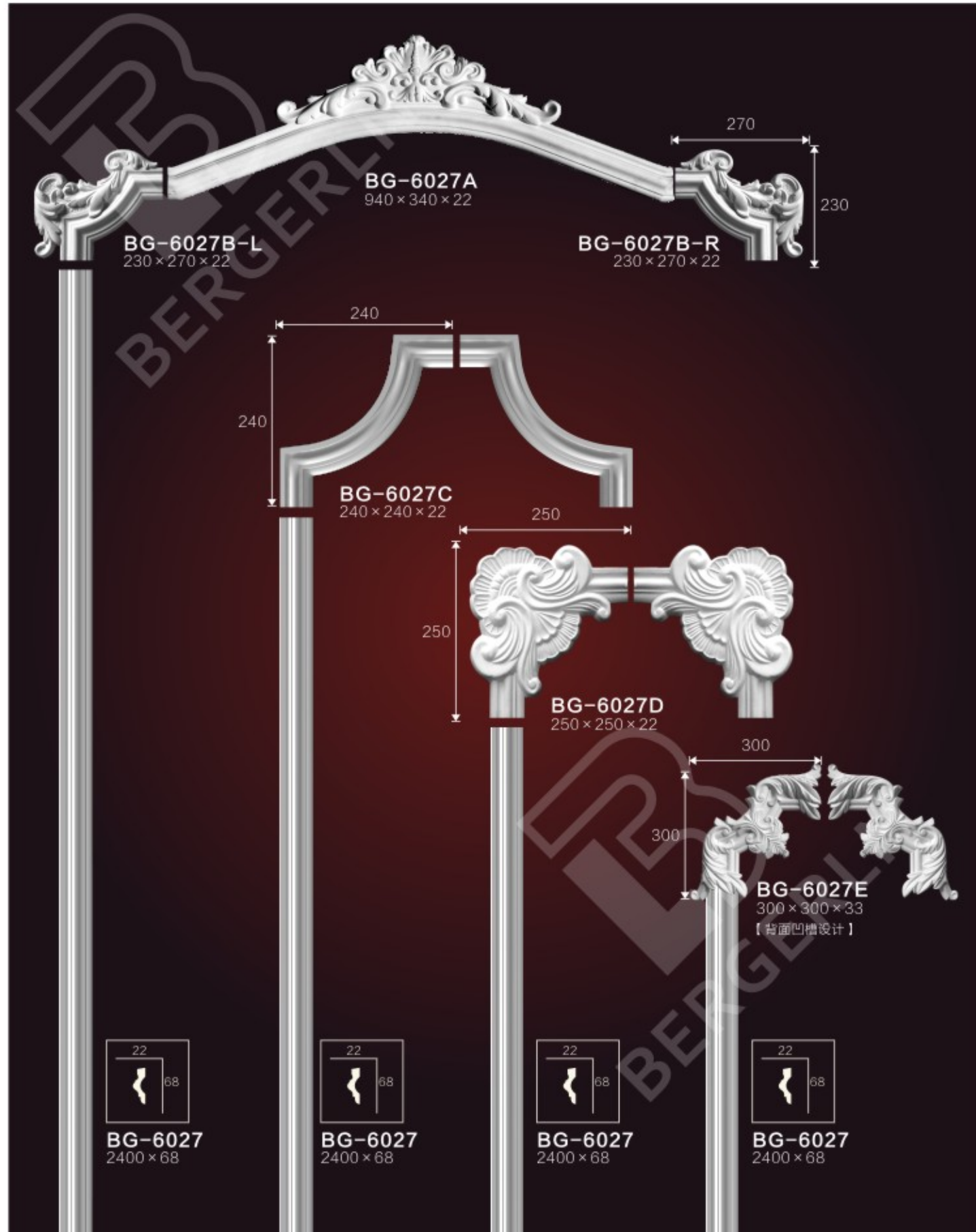

Size:mm

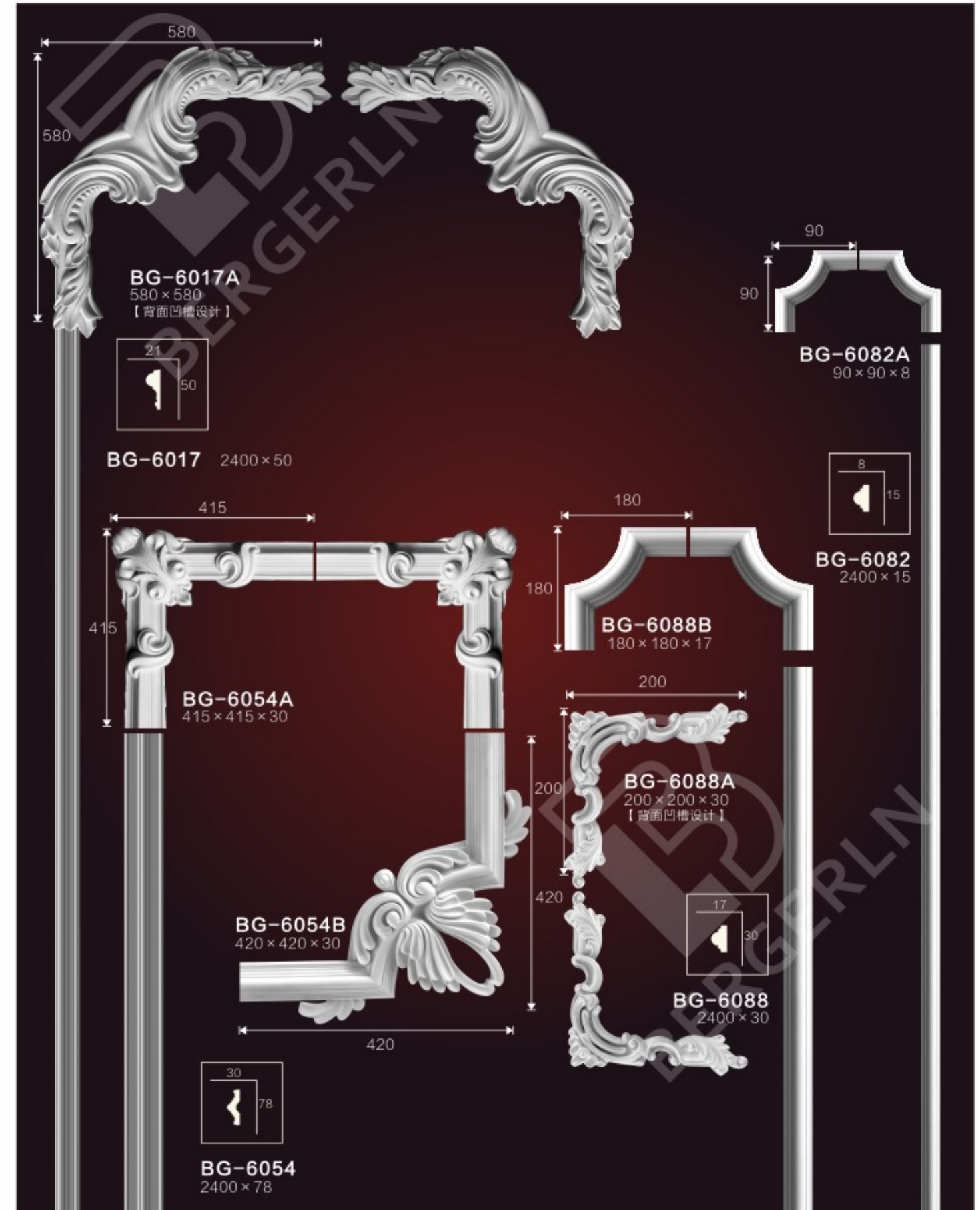

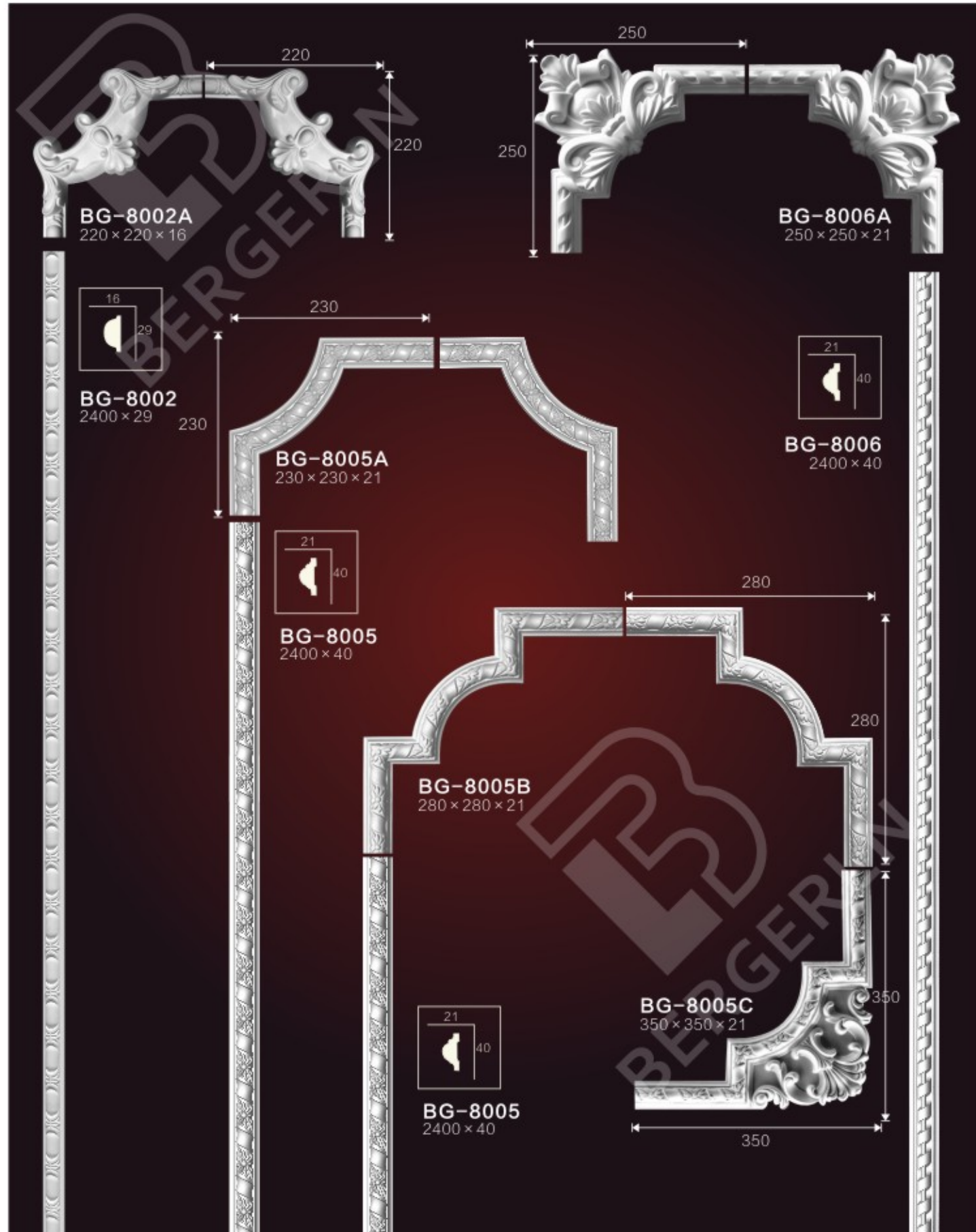

Size:mm

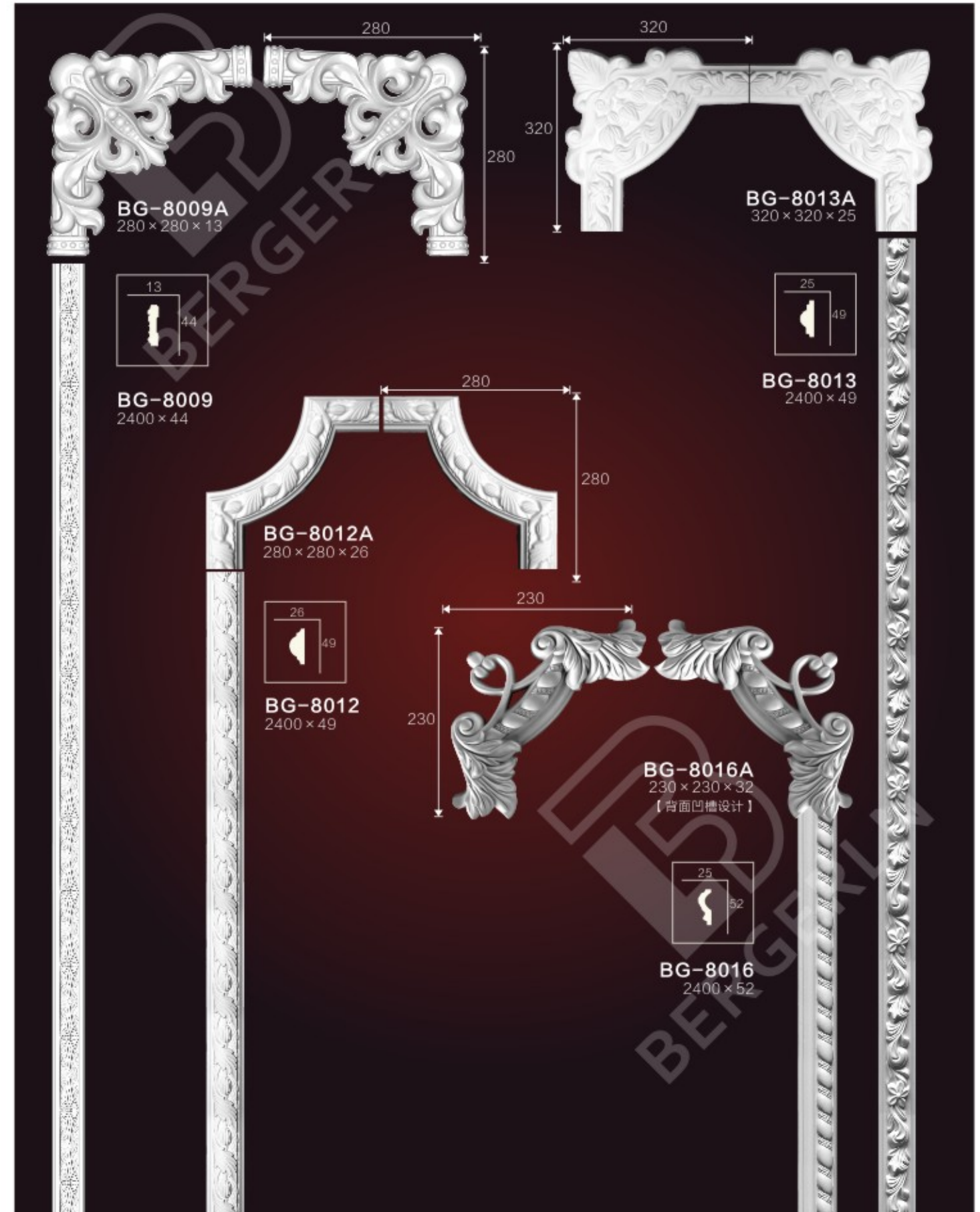

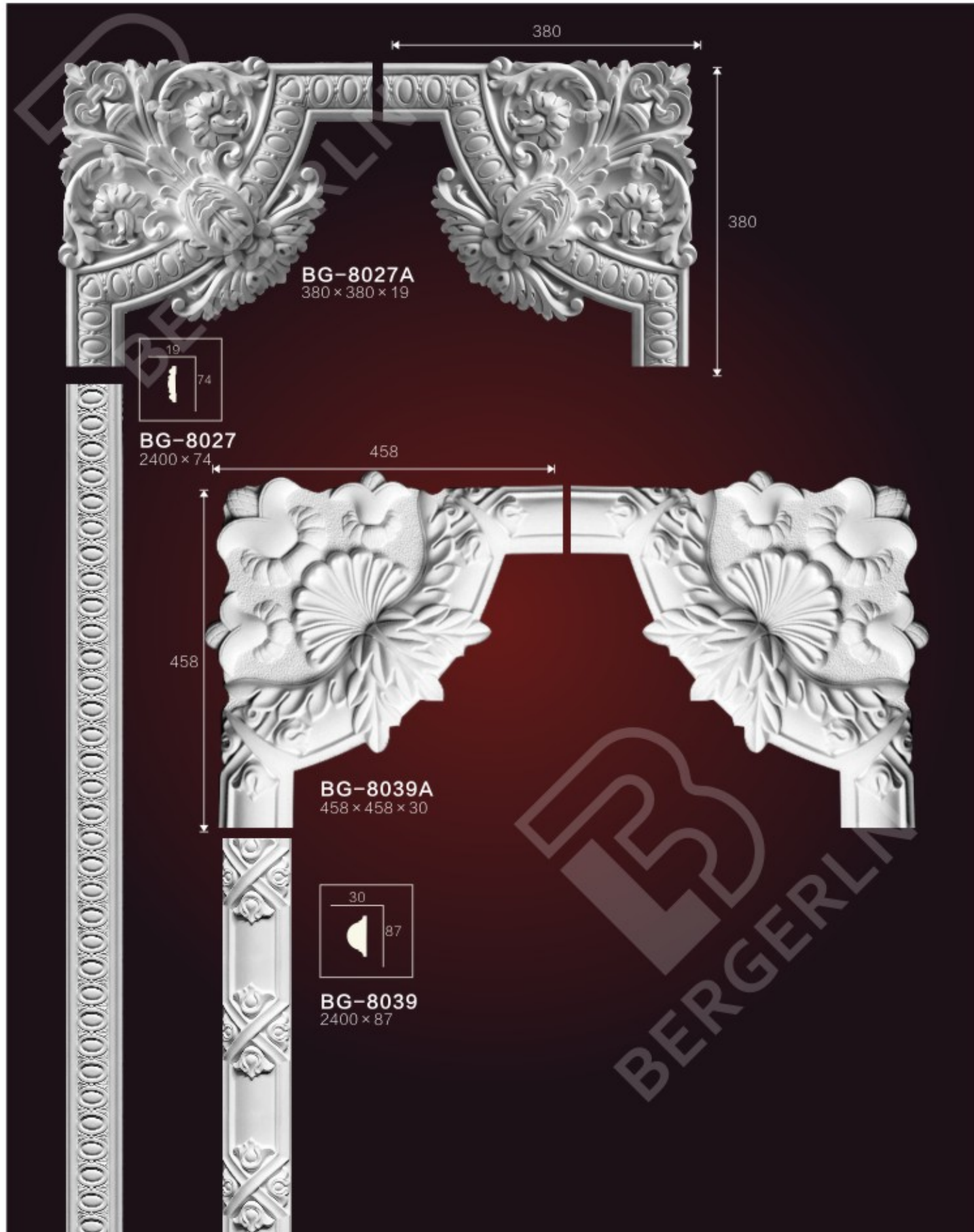

BERGERLN
Need Beauty, Make Beauty, Achieve Beauty, Have Beauty
OUJIYAZHI brings together a wide variety of top and wall elements from all over the world, satisfying not only the desire for home, but also the desire for large Spaces, and sometimes even the perfect window for designers and artisans to explore inspiration and ingenuity.





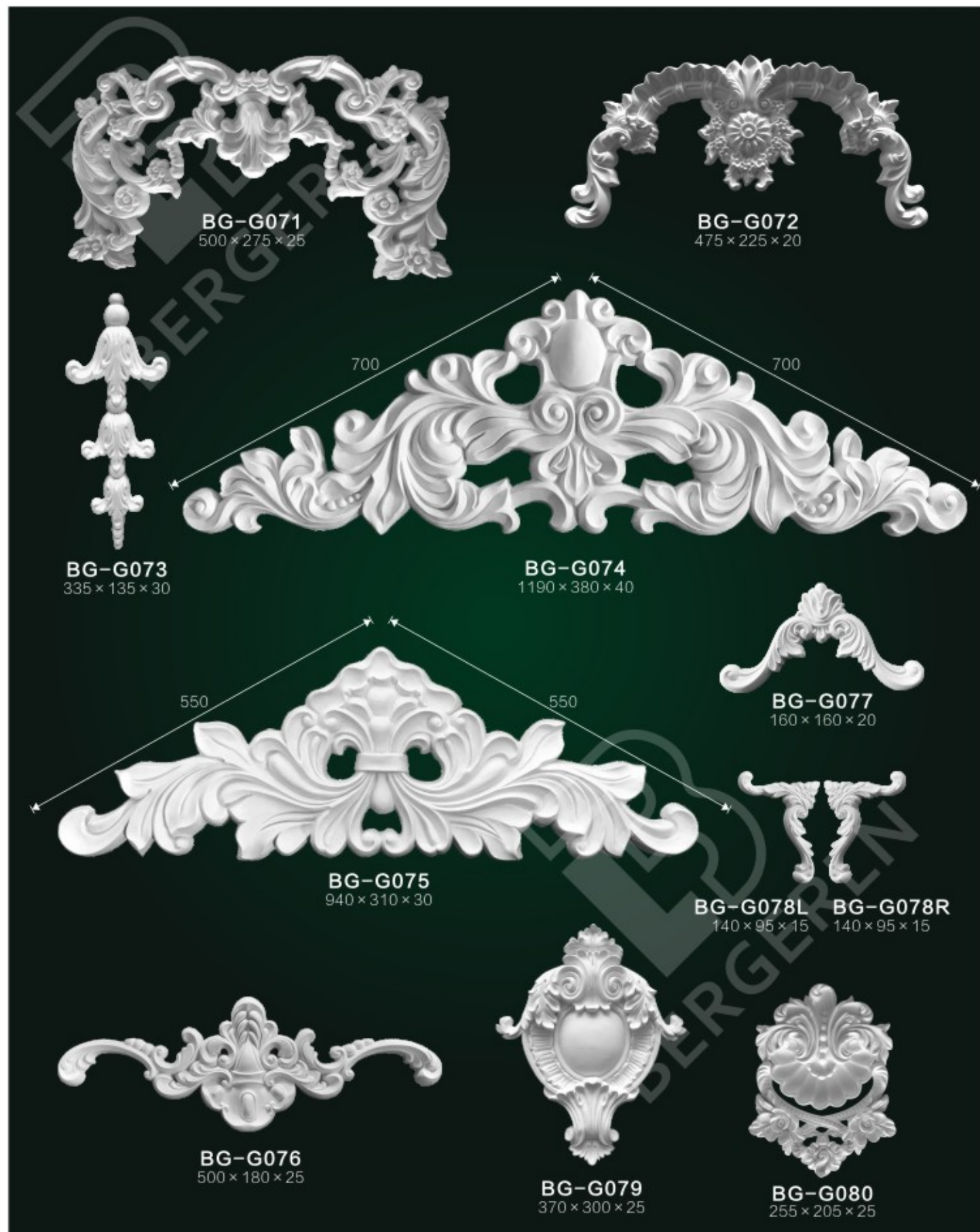

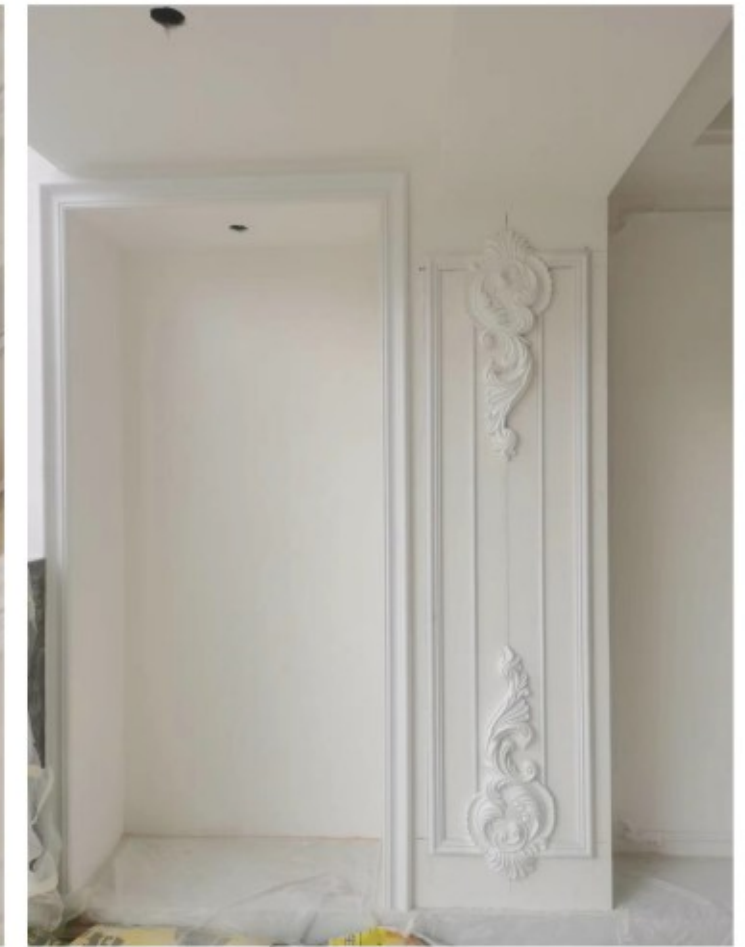
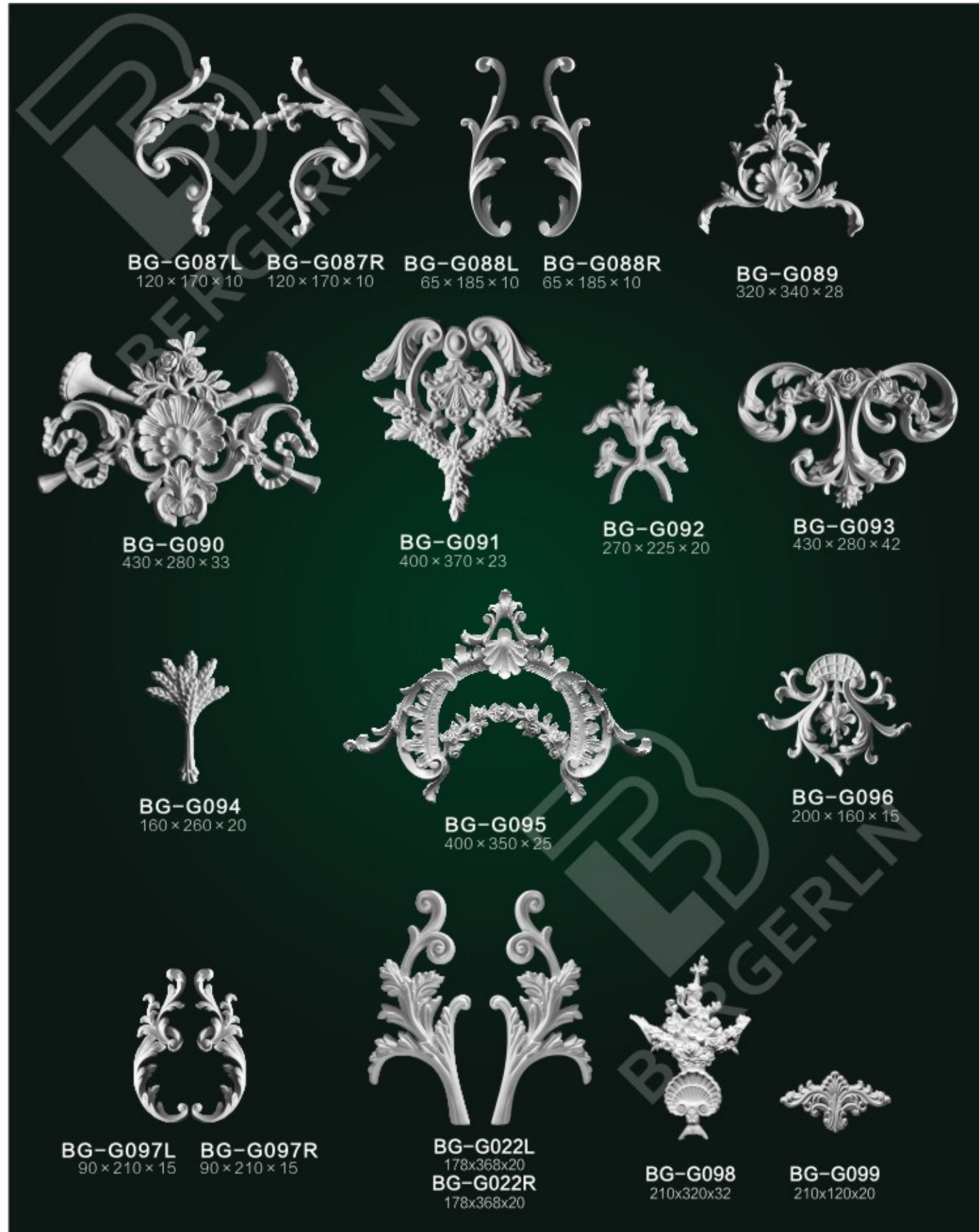

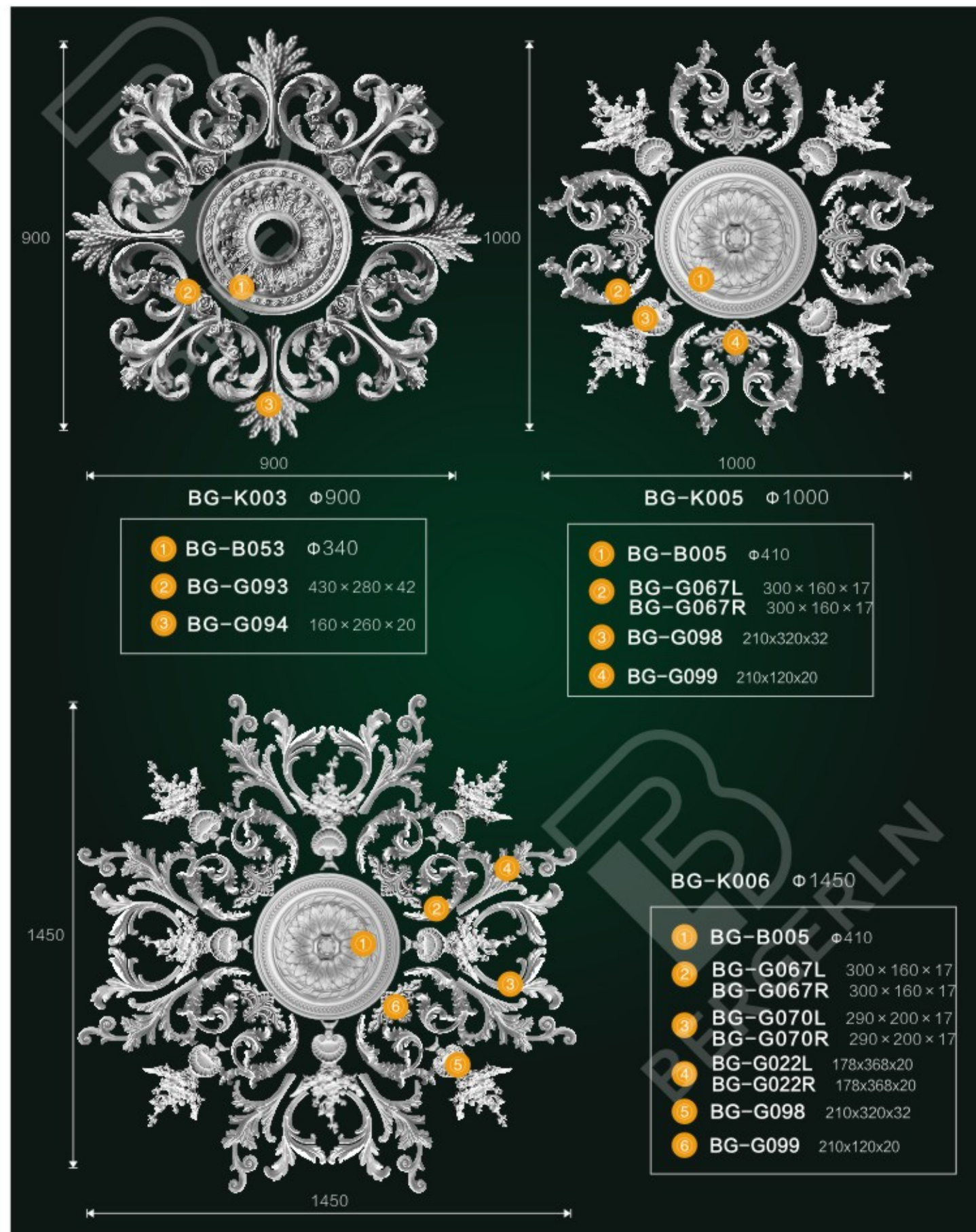
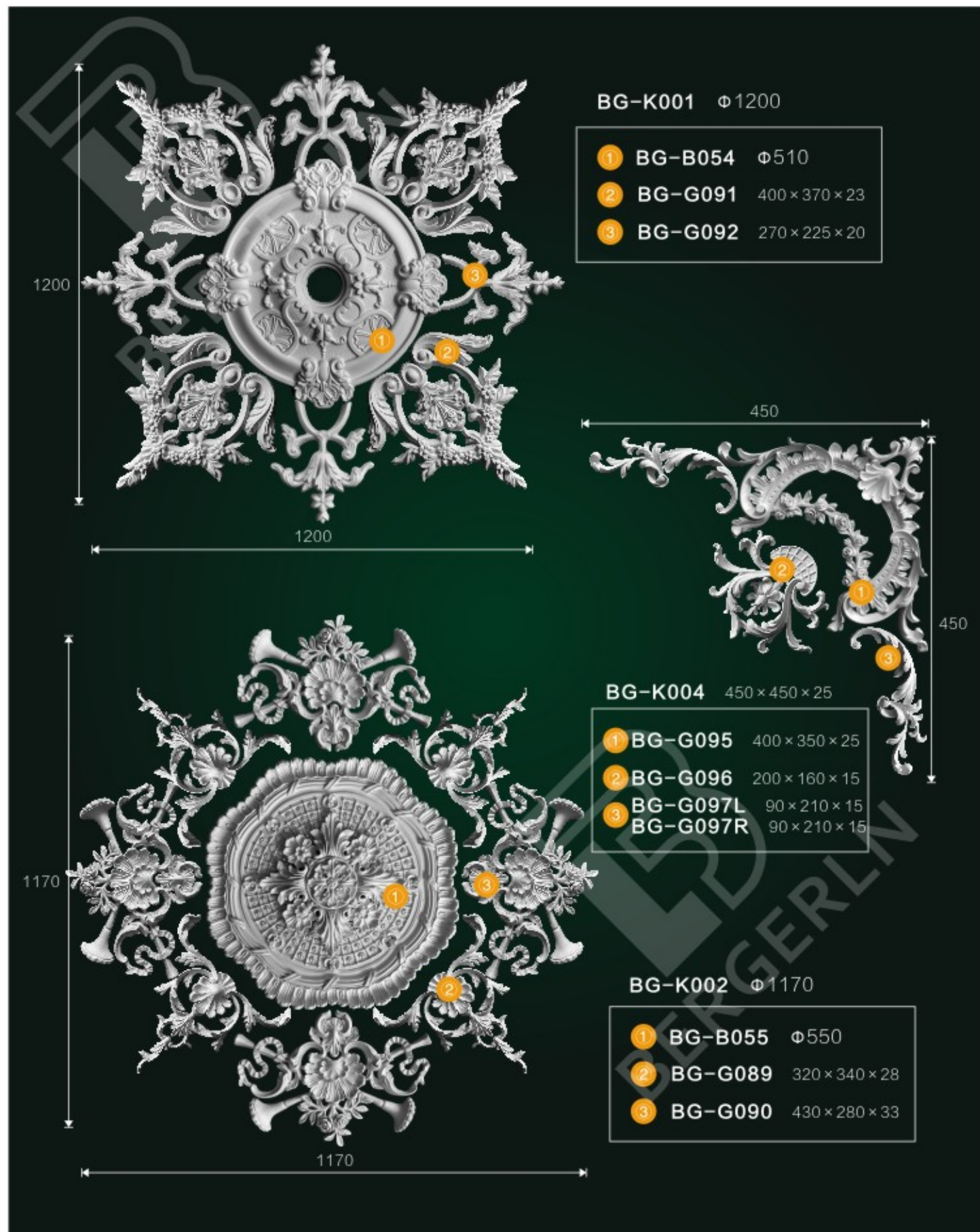

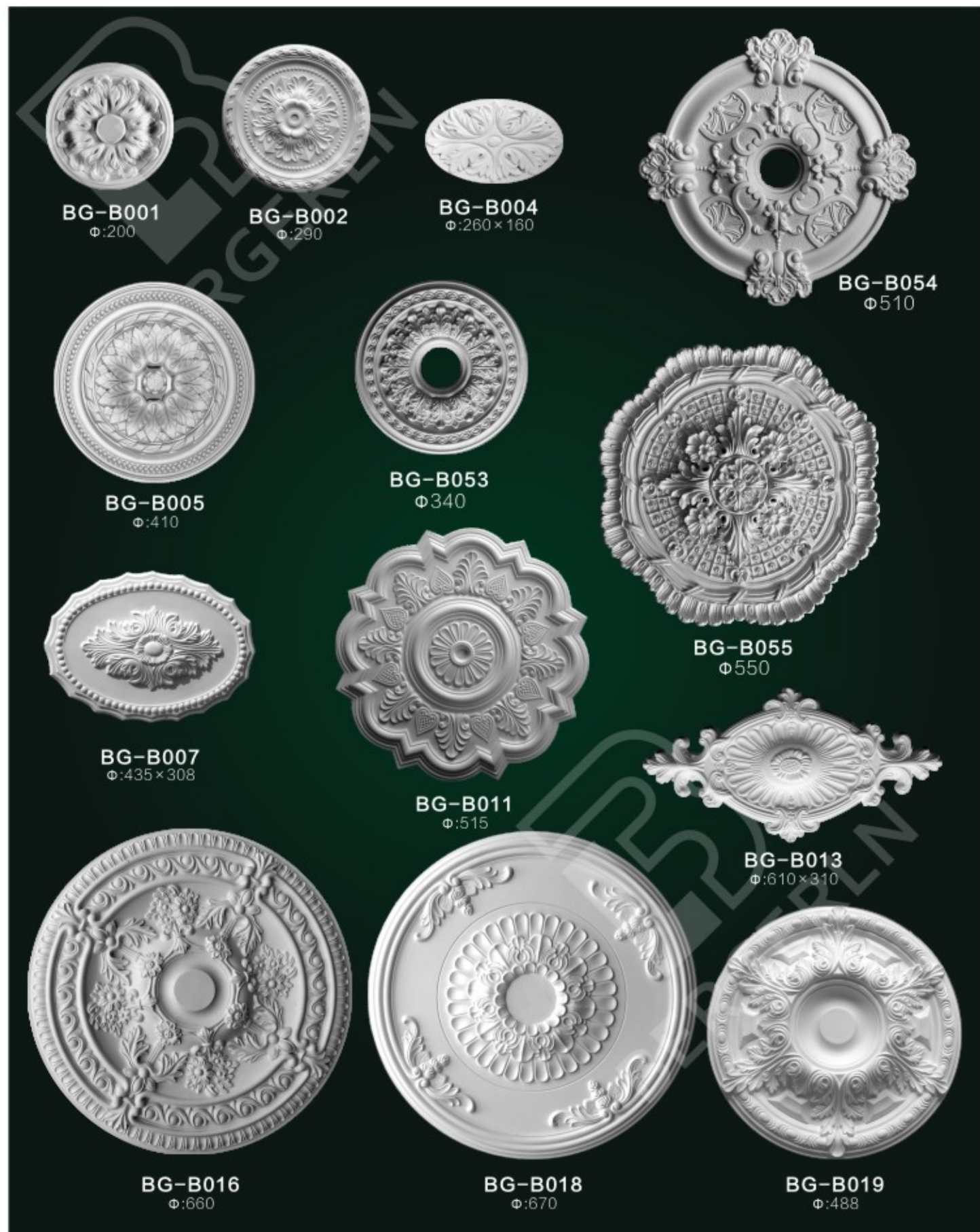





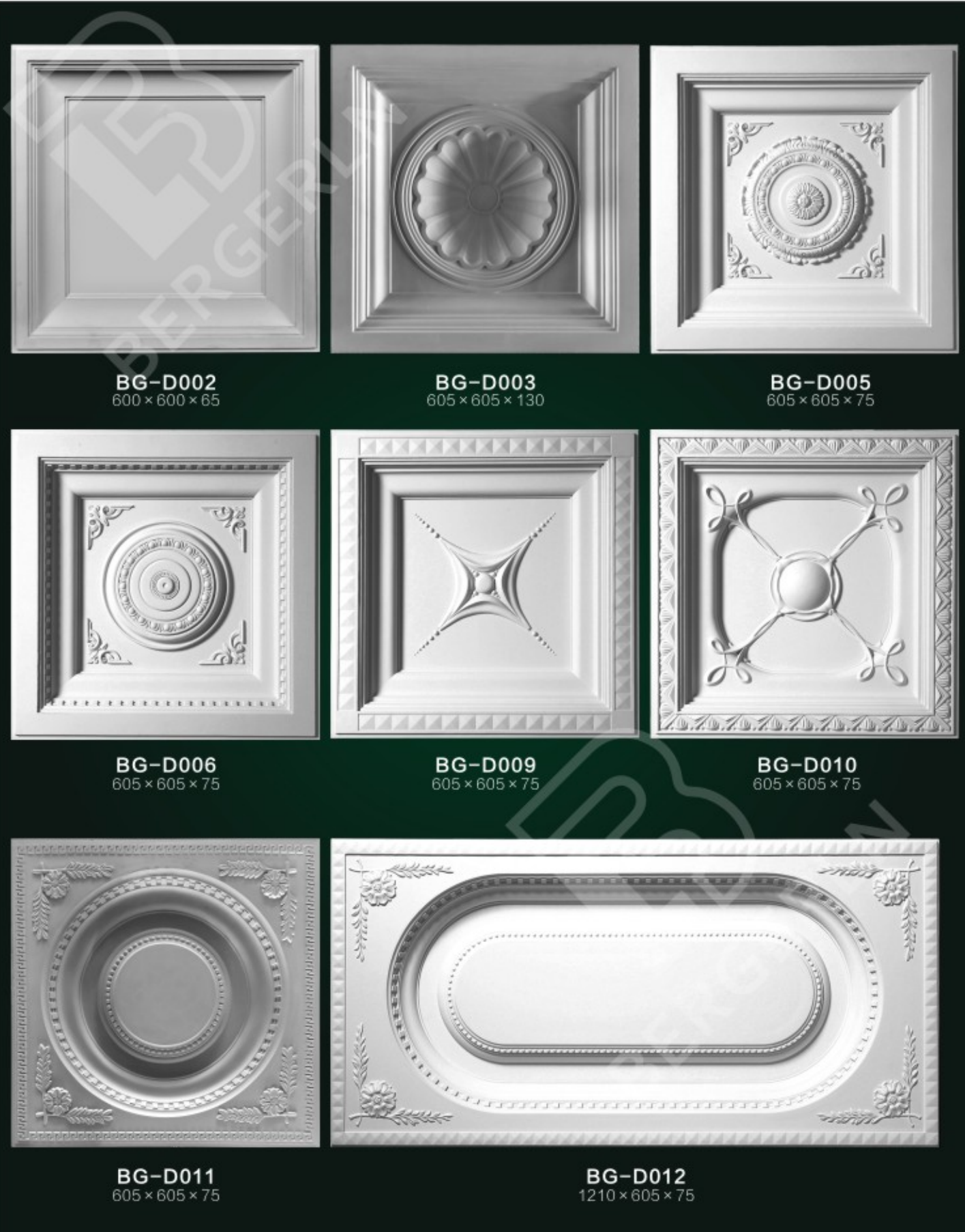

Size:mm





BG-M01
370 × 370 × 12



BG-S04
900 × 350 × 10



BG-M02
110 × 110 × 12

BG-M03
1800 × 100 × 12



BG-M04 1800 × 200 × 8



BG-M05 1800 × 300 × 8



The upper white acts as an under coat for any decorative paint.

Size:mm



BG-S01
600 × 600 × 12



BG-S02
600 × 600 × 12



BG-S03
600 × 600 × 12



BG-S05
600 × 600 × 12



BG-S06
600 × 600 × 12

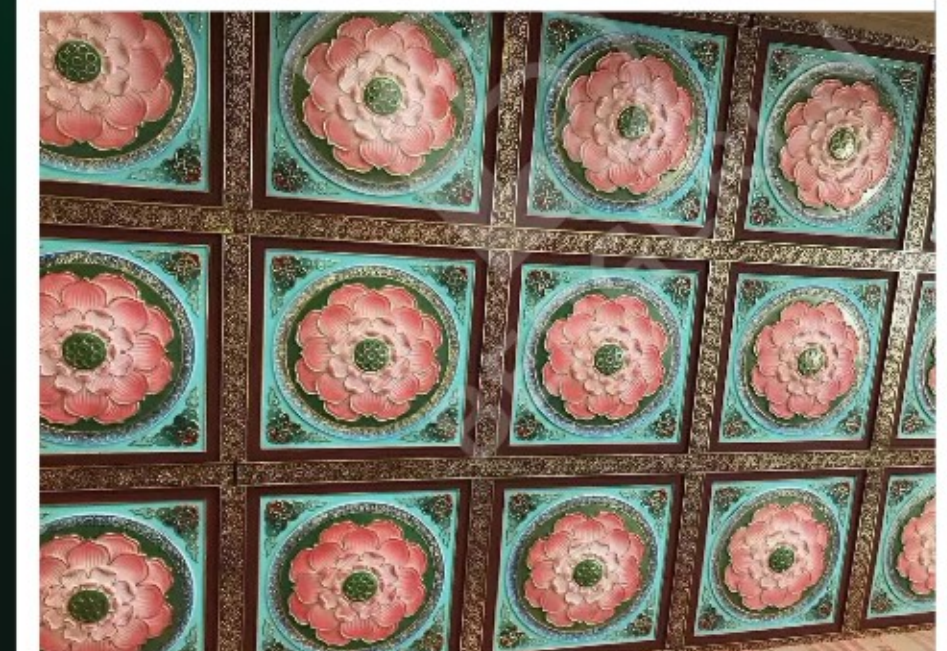

Welcome to choose **bergerln pu**

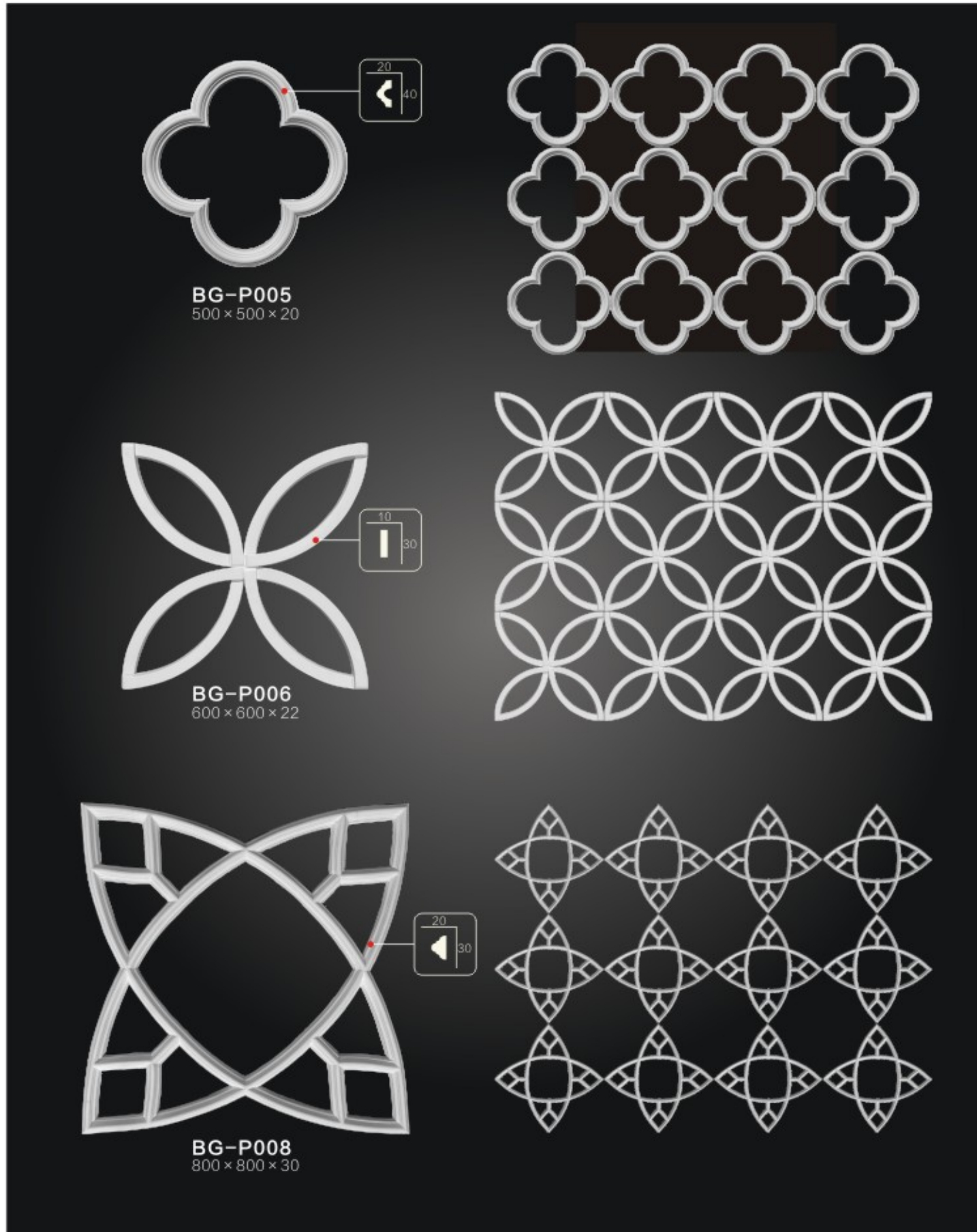

The upper white acts as an under coat for any decorative paint.

Size:mm

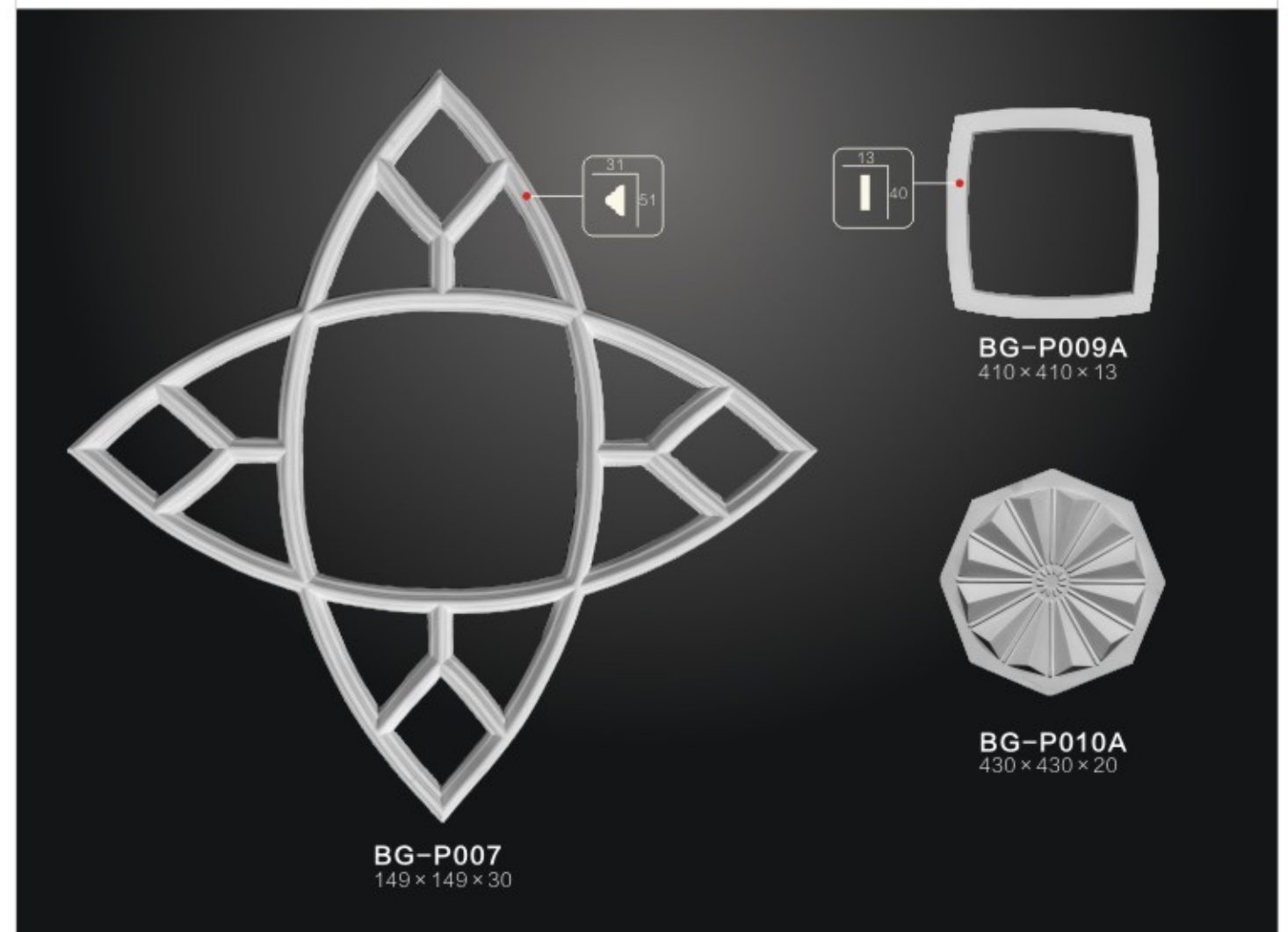

Welcome to choose **bergerln pu**

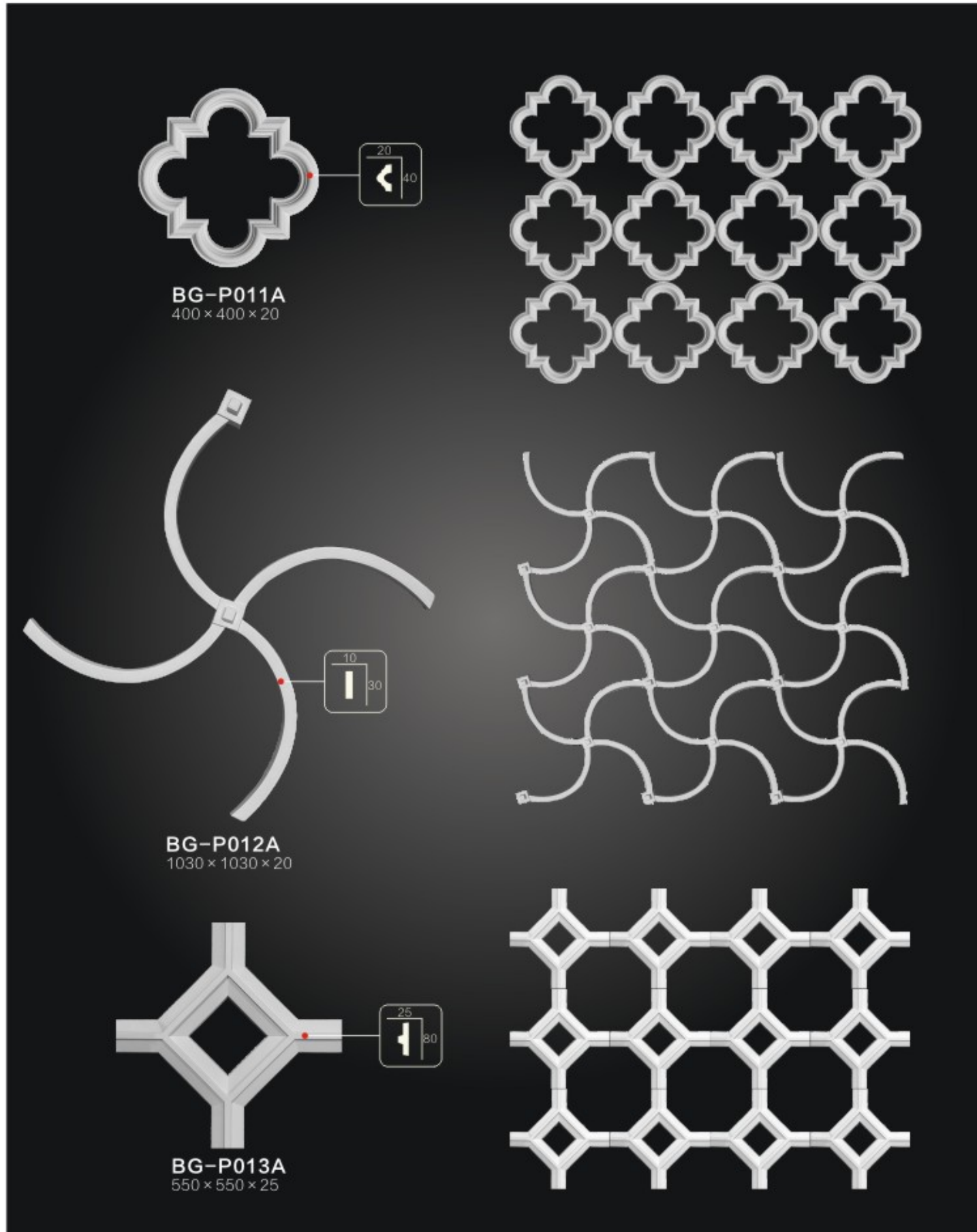

Size:mm







BG-P004
2000 × 300 × 25



BG-P009
2000 × 800 × 25



BG-P010
1200 × 300 × 15



BG-P011
2440 × 300 × 25



BG-P013
2440 × 300 × 30

Size:mm



	2	3
1	4	5
6	7	8

BG-P019
2400 × 1600
【仿古铜】



	2	3
1	4	5
6	7	8

BG-P019
2400 × 1600
【仿古银】





BG-J105
2235 × 450 × 20



BG-J104
2235 × 235 × 20



BG-J103
2245 × 615 × 20



BG-J102
2240 × 265 × 95

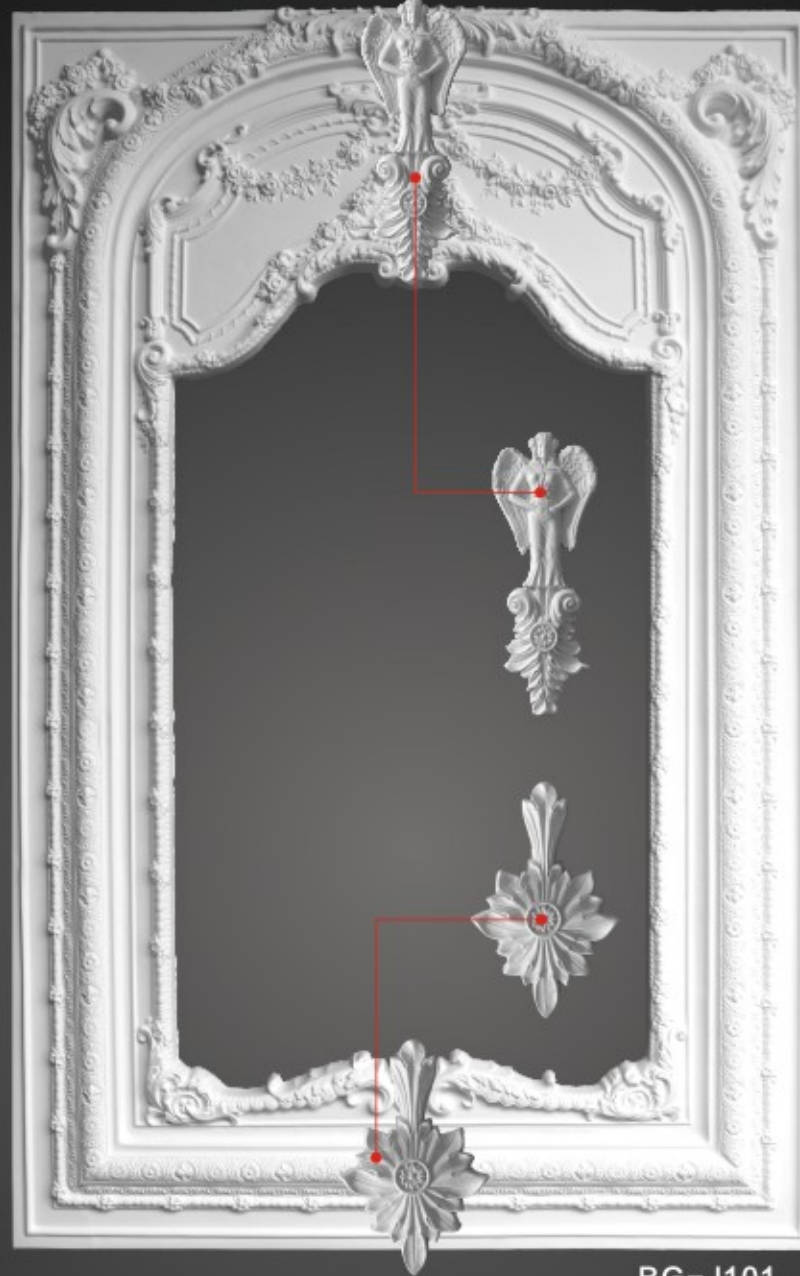

BG-J101
2235 × 1446 × 80



BG-J102
2240 × 265 × 95



BG-J103
2245 × 615 × 20



BG-J104
2235 × 235 × 20



BG-J105
2235 × 450 × 20



BG-J110
450 × 450 × 20



BG-J109
450 × 235 × 20



BG-J108
450 × 615 × 20



BG-J107
530 × 290 × 85



BG-J106
450 × 1446 × 20



BG-J107
530 × 290 × 85



BG-J108
450 × 615 × 20



BG-J109
450 × 235 × 20



BG-J110
450 × 450 × 20



BERGERLN

A romantic feeling you can't hide

BERGERLN designer abandoned the complicated and luxurious decoration and sweet color highlighted by the traditional French style, and chose the simple and elegant, low-key design to create a modern sense of light luxury. It mainly highlights the symmetrical layout, combined with geometric lines and light spatial colors, to create a space style of French light luxury.



The upper white acts as an under coat for any decorative paint.

Size:mm



Welcome to choose **bergerln pu**

BERGERLN

From the Angle of vision for, light color and brunet are compared, it's a kind of relatively comfortable, downy tonal, plus a few bright color ornament, can make whole space has the feeling of harmony and unity already, highlighted visual level feeling again, add a lot of life and temperature to the space.

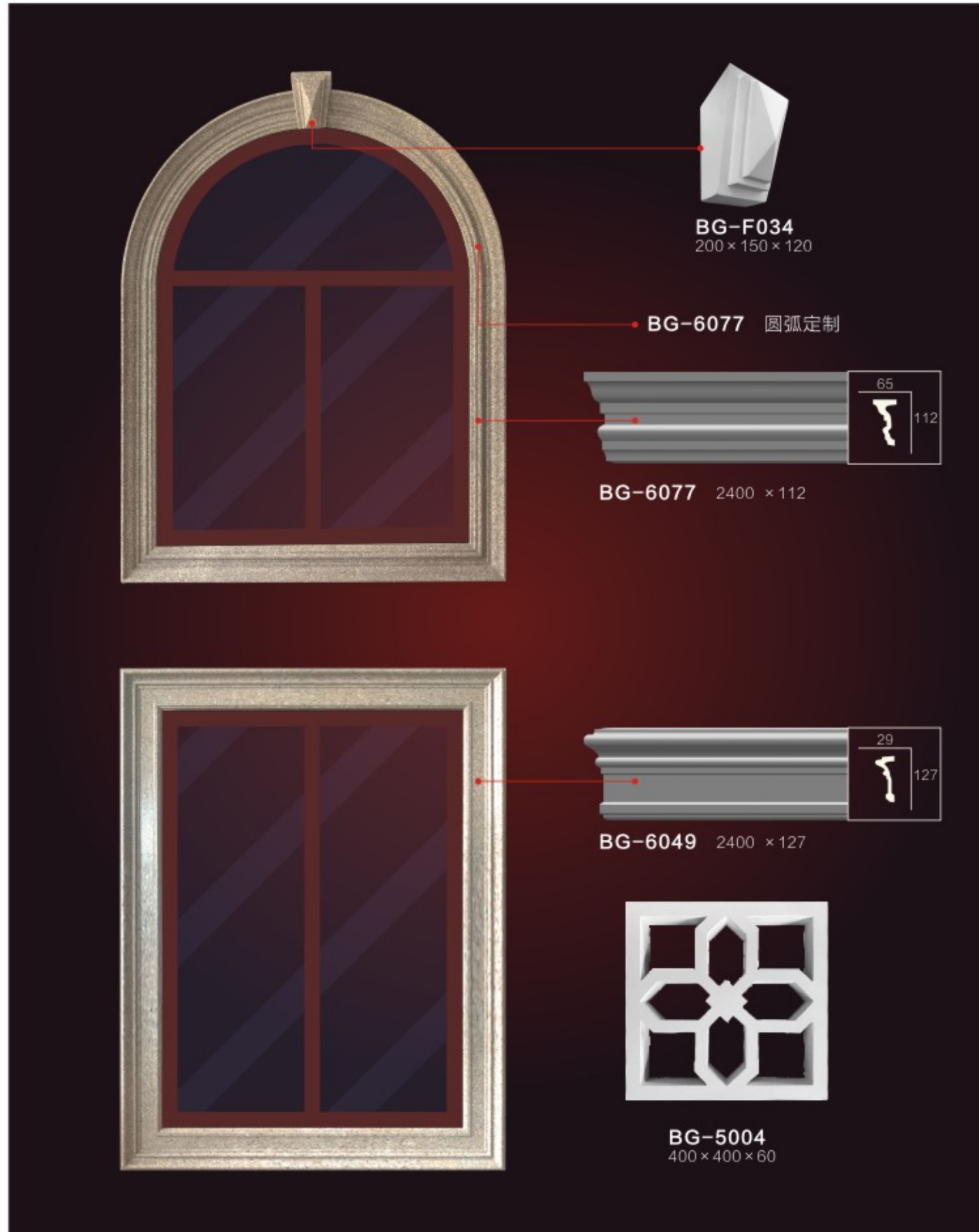

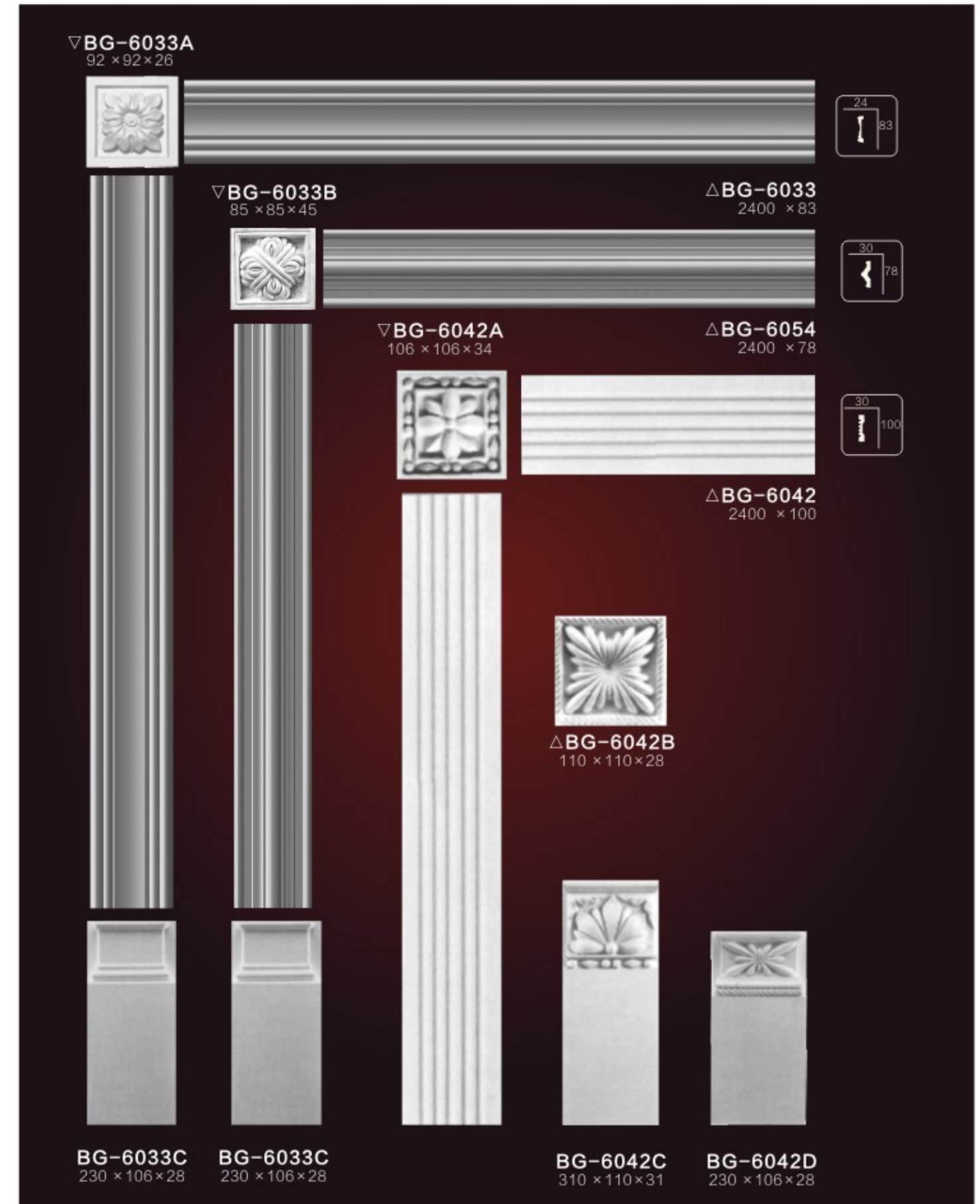
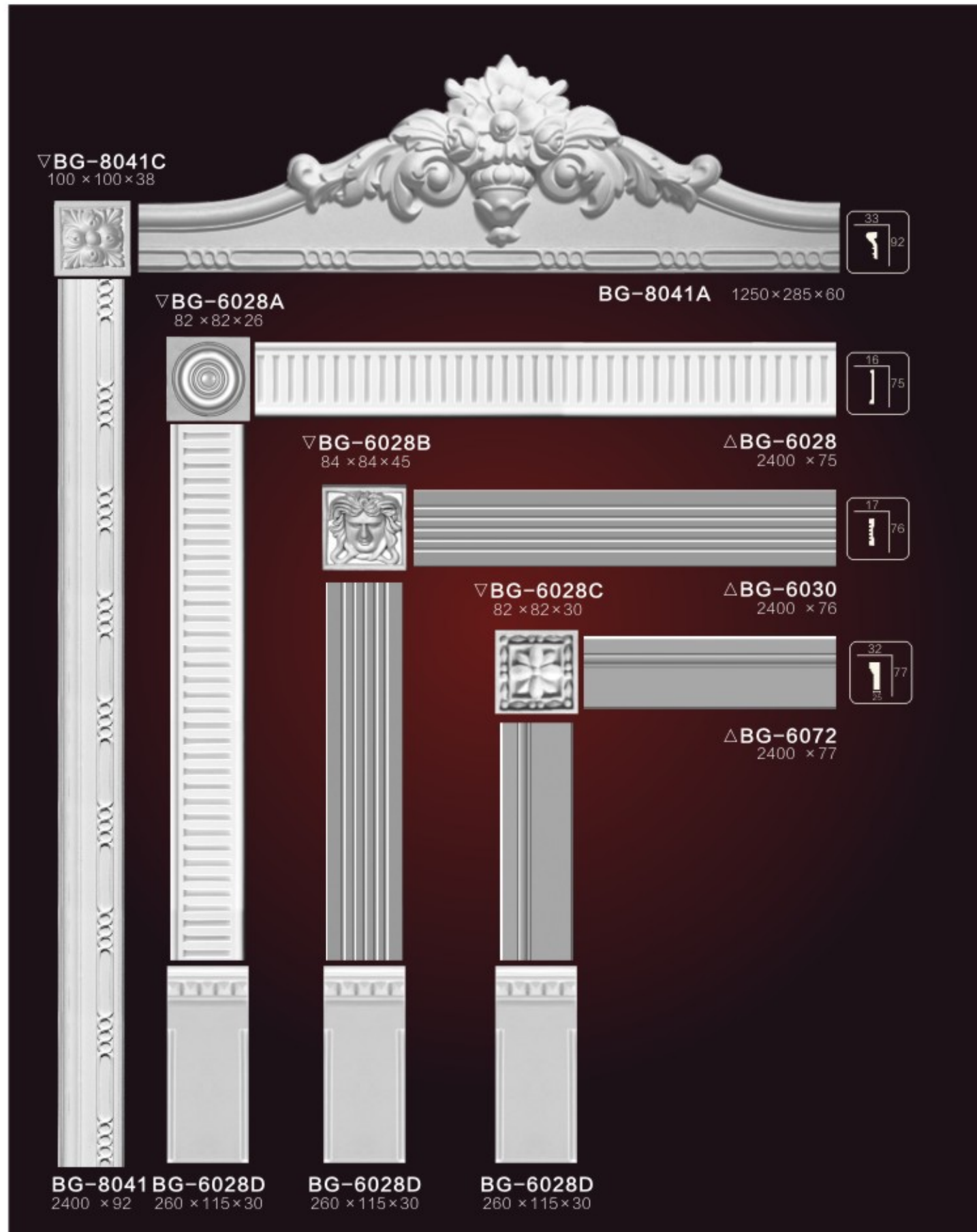



Size:mm



Size:mm



BG-WS009
596×250×(10-15)MM



BG-WS010
596×250×(10-15)MM

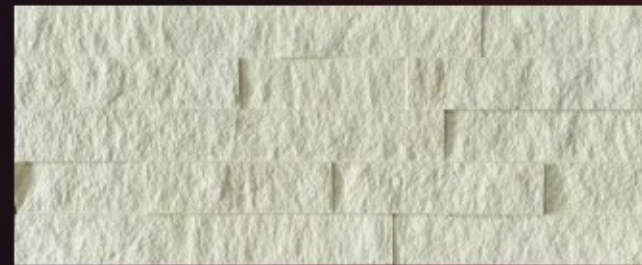

BG-WS011
596×250×(10-15)MM



BG-WS012
596×250×(10-15)MM



BG-WS013
596×250×(10-15)MM



BG-WS014
596×250×(10-15)MM



Free Combination

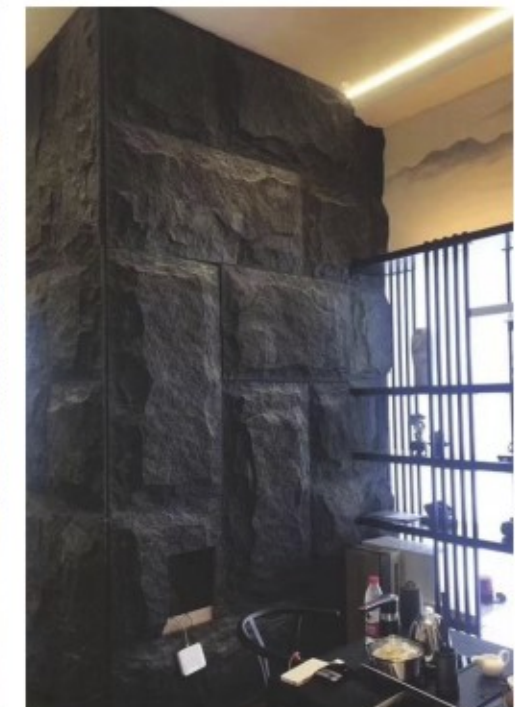
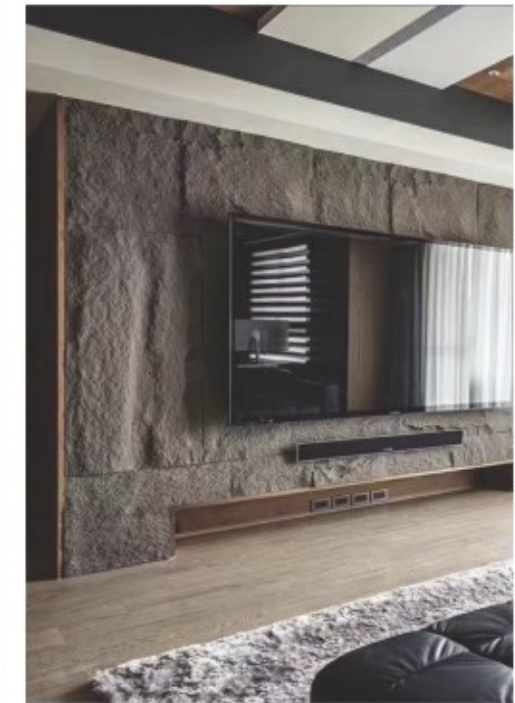

BERGERLN CULTURE STONE

Fast Beautiful & Low Cost

It can have high elasticity and strength in a wide range of hardness, excellent wear resistance, oil resistance, fatigue resistance and shock resistance, and excellent comprehensive performance, so that PU light SLATE has been widely used in China.